



Green Infrastructure Plan

July 2019

This page intentionally left blank

Acknowledgments

The City of Hayward acknowledges the contributing authors and reviewers of this Green Infrastructure (GI) Plan:

City of Hayward

Public Works & Utilities Department
Development Services Department

Consultants to City of Hayward

Geosyntec Consultants
Horizon Water and Environment

Other Agencies

- Alameda Countywide Clean Water Program (ACCWP) developed the ArcGIS Online (AGOL) tool and GI mechanism used for prioritizing, mapping, tracking, and reporting GI projects; as well as GI guidelines, example typical designs, and related information.
- San Mateo Countywide Water Pollution Prevention Program shared information regarding funding mechanisms and provided several images used in the GI guidelines. The Bay Area Stormwater Management Agencies Association developed sizing guidelines for GI facilities located in roadway right of way that are constrained from meeting standard hydraulic sizing criteria.

Table of Contents

List of Acronyms	iv
1. Introduction	1
1.1 Statement of Purpose	1
1.2 MRP Requirements	1
2. Prioritizing and Mapping Planned and Potential Projects	3
2.1 Approach for Prioritizing and Mapping Projects (GI Mechanism)	3
2.2 Summary of Prioritized Projects (Outputs of the GI Mechanism)	6
2.3 Impervious Surface Retrofit Targets	8
2.4 Early Implementation Projects.....	9
2.5 GI Implementation in Private Developments	9
3. Tracking and Mapping Completed GI Projects	11
3.1 Project Tracking and Load Reduction Accounting Tool	11
3.2 Making Information Publicly Available	11
4. Summary of General Guidelines for GI Projects	13
4.1 Implementing Projects with a Unified, Complete Design.....	13
4.2 Hydraulic Sizing Requirements	13
4.3 Standard Specifications and Typical Designs	14
5. GI Requirements in Other Planning Documents.....	15
5.1 Summary of Updated Planning Documents.....	15
5.2 Anticipated Updates of Additional Planning Documents	15
6. Evaluation of Funding Options	17
6.1 Evaluation Criteria	17
6.2 Recommendations	17
7. References.....	19

Appendices

Appendix A. Map and List of Prioritized Projects

Appendix B. General Guidelines for GI Projects

- Attachment B-1: Hydraulic Sizing Criteria
- Attachment B-2: Worksheet for Calculating the Combination Flow and Volume Method
- Attachment B-3: Mean Annual Precipitation Map
- Attachment B-4: Standard Specifications and Typical Details
- Attachment B-5: Capital Improvement Projects Sign-off Form
- Attachment B-6: Guidance for Sizing Green Infrastructure Facilities in Street Projects

Appendix C. Workplan to Incorporate Green Infrastructure Requirements in City of Hayward’s Bicycle and Pedestrian Master Plan Update

List of Tables

Table 1-1: GI Plan Sections and Applicable MRP Provisions	2
Table 2-1: Target Amounts of Existing Impervious Surface to be Retrofitted by 2020, 2030 and 2040	8
Table 4-1: Where to Find Hydraulic Sizing Guidance and Other Guidance - by Project Type	14

List of Acronyms

Acronym	Definition
ABAG	Association of Bay Area Governments
ACCWP	Alameda Countywide Clean Water Program
AGOL	ArcGIS Online
BAHM	Bay Area Hydrology Model
BART	Bay Area Rapid Transit District
BASMAA	Bay Area Stormwater Management Agencies Association
CASQA	California Stormwater Quality Association
CIP	Capital Improvement Program
DMA	drainage management area
GI	green infrastructure
GIS	geographic information system
HARD	Hayward Area Recreation & Parks District
HM	hydromodification management
LID	low impact development
MAP	mean annual precipitation
MRP	Municipal Regional Stormwater Permit
MTC	Bay Area Metropolitan Transportation Commission
PCBs	polychlorinated biphenyls
ROW	right-of-way
RWQCB	Regional Water Quality Control Board
SMCWPPP	San Mateo Countywide Water Pollution Prevention Program
SWRP	Stormwater Resource Plan
TMDL	total maximum daily load

1. Introduction

1.1 Statement of Purpose

The purpose of the Green Infrastructure Plan is to guide the identification, implementation, tracking, and reporting of green infrastructure projects within the City of Hayward (City), in accordance with the Municipal Regional Stormwater Permit (MRP), Order No. R2-2015-0049, adopted by the San Francisco Bay Regional Water Quality Control Board on November 15, 2015. “Green infrastructure” (GI) refers to a sustainable system that slows runoff by dispersing it to vegetated areas, harvests and uses runoff, promotes infiltration and evapotranspiration, and uses bioretention and other low impact development practices to clean stormwater runoff.

1.2 MRP Requirements

This GI Plan has been developed to comply with GI Plan requirements in Provision C.3.j of the MRP, which states in part:

The Plan is intended to serve as an implementation guide and reporting tool during this and subsequent Permit terms to provide reasonable assurance that urban runoff Total maximum daily load (TMDL) wasteload allocations (e.g., for the San Francisco Bay mercury and polychlorinated biphenyls (PCBs) TMDLs) will be met, and to set goals for reducing, over the long term, the adverse water quality impacts of urbanization and urban runoff on receiving waters. For this Permit term, the Plan is being required, in part, as an alternative to expanding the definition of Regulated Projects prescribed in Provision C.3.b to include all new and redevelopment projects that create or replace 5,000 square feet or more of impervious surface areas and road projects that just replace existing impervious surface area. It also provides a mechanism to establish and implement alternative or in-lieu compliance options for Regulated Projects and to account for and justify Special Projects in accordance with Provision C.3.e.

Over the long term, the Plan is intended to describe how the Permittees will shift their impervious surfaces and storm drain infrastructure from gray, or traditional storm drain infrastructure where runoff flows directly into the storm drain and then the receiving water, to green—that is, to a more-resilient, sustainable system that slows runoff by dispersing it to vegetated areas, harvests and uses runoff, promotes infiltration and evapotranspiration, and uses bioretention and other green infrastructure practices to clean stormwater runoff.

The Plan shall also identify means and methods to prioritize particular areas and projects within each Permittee’s jurisdiction, at appropriate geographic and time scales, for implementation of green infrastructure projects. Further, it shall include means and methods to track the area within each Permittee’s jurisdiction that is treated by green infrastructure controls and the amount of directly connected impervious area. As

appropriate, it shall incorporate plans required elsewhere within this Permit, and specifically plans required for the monitoring of and to ensure appropriate reductions in trash, PCBs, mercury, and other pollutants.

Table 1-1 below links each section of this plan to the applicable MRP provision.

Table 1-1: GI Plan Sections and Applicable MRP Provisions

Section of GI Plan	Applicable MRP Provision
1. Introduction	C.3.j
2. Prioritizing and Mapping Planned and Potential Projects	C.3.j.i.(2) (a) – (c), & C.3.j.i.(2) (j)
2.1 Approach for Prioritizing and Mapping Projects	C.3.j.i.(2) (a)
2.2 Summary of Prioritized Projects	C.3.j.i.(2) (b)
2.3 Impervious Surface Retrofit Targets	C.3.j.i.(2) (c)
2.4 Early Implementation Projects	C.3.j.i.(2) (j)
3. Tracking and Mapping Completed Projects	C.3.j.i.(2) (d) & C.3.d.iv.(1)
4. Summary of General Guidelines for GI Projects	C.3.j.i.(2) (e), C.3.j.i.(2) (f), & C.3.j.i.(2) (g)
5. Relationship to Other Planning Documents	C.3.j.i.(2) (h) & (i)
6. Evaluation of Funding Options	C.3.j.i.(2) (k)
Appendix A. <i>Map and List of Prioritized Projects</i>	C.3.j.i.(2) (b)
Appendix B. <i>General Guidelines for GI Projects</i>	C.3.j.i.(2) (e), C.3.j.i.(2) (f), & C.3.j.i.(2) (g)
Appendix C. <i>Workplan to Incorporate GI Requirements in City of Hayward's Bicycle and Pedestrian Master Plan Update</i>	C.3.j.i.(2) (i)

2. Prioritizing and Mapping Planned and Potential Projects

Section 2 describes the use of a mechanism for prioritizing and mapping GI projects as required in Provision C.3.j.i.(2)(a), provides a summary description of prioritized GI projects and other outputs of the mechanism per Provision C.3.j.i.(2)(b), presents targets for areas of impervious surface to be retrofitted as required in Provision C.3.j.i.(2)(c), and discusses prioritized projects for early implementation.

2.1 Approach for Prioritizing and Mapping Projects (GI Mechanism)

This section describes the Alameda Countywide GI Mechanism (“GI Mechanism”) used to prioritize and map areas for planned and potential GI projects. The mechanism consists of the Alameda Countywide Multi-Benefit Metrics Prioritization Protocol (“prioritization protocol”) interface, with the Alameda County/Contra Costa Project Tracking and Load Reduction Accounting Tool ArcGIS Online web application (“AGOL tool”). To date, the mechanism has been used as the basis to prioritize and map public GI projects for implementation by 2020, by 2030, and by 2040 by the City of Hayward, as described below. It also includes capabilities to prioritize and map private projects, where appropriate.

As described below, the mechanism provides baseline criteria for prioritization, such as specific feasibility constraints, water quality drivers (load reductions of mercury and PCBs consistent with TMDLs), and opportunities to treat runoff from private parcels in street right-of-way (ROW). It also produces outputs, including geospatial data for prioritized projects, which can be mapped, and project lists. Project opportunity locations identified through utilization of the GI Mechanism were further screened and prioritized through additional City project opportunity classification and discussion, described in the following sections. The screened and prioritized GI Mechanism output was used to develop a map and list of planned GI projects, which can be incorporated into City of Hayward’s long-term planning and capital improvement processes. The City of Hayward planned GI projects are included in Appendix A, *Map and List of Prioritized Projects*.

Prioritization of Areas for Planned and Potential Projects

The Master List of Prioritized Projects included in Appendix A was developed using outputs of the GI Mechanism. The prioritization protocol that produced these outputs included a stepwise geographic information system (GIS) analysis documented in the Alameda Countywide Stormwater Resource Plan Screening and Prioritization using Multi-Benefit Metrics Technical Memorandum¹, along with additional classification and prioritization applied by the City of Hayward. The GI project prioritization steps are summarized below.

¹ Geosyntec. 2017. Alameda Countywide Stormwater Resource Plan Screening and Prioritization using Multi-Benefit Metrics Technical Memorandum. December 13.

Step 1. Identify planned projects – Planned future GI projects within Alameda County were identified and entered into a GIS layer, based on project information provided by local agencies within the county.

Step 2. Identify opportunity sites – Additional potential project locations were identified and catalogued by the Alameda Countywide Clean Water Program consultant Geosyntec using a GIS-based opportunity analysis. The project opportunity analysis followed the steps listed below:

- a. Identify publicly-owned parcels.
- b. Screen identified public parcels to include only those that are at least 0.1 acre in size and with an average slope of less than 10 percent. Parcels that met these criteria were screened for physical feasibility.
- c. Identify non-interstate highway public ROW within urban areas. Roadways considered included state and county highways and connecting roads and local, neighborhood, and rural roads.
- d. Identify land uses or adjacent land uses of the sites resulting from steps b and c.
- e. Screen sites identified in steps b and c to remove sites with the following physical constraints:
 - i. Regional facilities were not considered for sites that were greater than 500 feet from a storm drain due to limited feasibility in treating runoff from a larger drainage area;
 - ii. Parcel-based facilities were not considered for sites that were more than 50% undeveloped due to the limited potential for pollutant reduction of concern load reduction;
 - iii. Sites with more than 50% of their drainage area outside of the urbanized area, as these sites would not provide opportunity for significant pollutant of concern load reduction;
 - iv. Sites with more than 50% overlying landslide hazard zones to avoid the potential for increasing landslide risk.

Step 3. Classify planned projects and opportunity sites in preparation for metrics-based evaluation – A GIS analysis was performed to classify the planned projects identified in step 1 and the opportunity sites identified in step 2 according to four parameters listed below:

- a. GI project type – Each project received one of the following classifications: parcel-based, regional, or ROW/green street project.
- b. Infiltration feasibility - Each project location received one of the following classifications for infiltration: infeasible, partially feasible, or feasible.

- c. Facility type – Each project received one of the following classifications: GI², non-GI treatment control facility, water supply augmentation, flood control facility, hydromodification control, public use area or public education area, programmatic stormwater management opportunity.
- d. Drainage area information – A drainage area was identified for each project.

Step 4. Score projects using an automated metrics-based evaluation – A quantitative metrics-based multiple benefit evaluation was performed using an automated process. Projects or opportunity sites received a score of 0, 1, or 2 for each of the 14 metrics listed below. The automated scores were used to preliminarily rank the projects by watershed, jurisdiction, project type, and/or project stakeholder(s). Geosyntec provided a jurisdiction-specific list of planned projects and opportunity sites located in City of Hayward, including an automated score for each project. Spatial data for the projects included in the list were provided in both GIS shape file and Google Earth KMZ file formats.

- a. Parcel area (for regional and parcel-based projects only)
- b. Location slope
- c. Infiltration feasibility
- d. PCBs/mercury yield classification in project drainage area
- e. Regional facility
- f. Removes pollutant loads from stormwater
- g. Augments water supply
- h. Provides flood control benefits
- i. Re-establishes natural water drainage systems
- j. Develops, restores, or enhances habitat and open space
- k. Provides enhanced or created recreational and public use areas with potential opportunities for community involvement and education
- l. Trash capture co-benefit

Step 5. Rank the projects based on local considerations – City of Hayward reviewed the jurisdiction-specific list of planned projects and opportunity sites developed through step 4 as part of preparing the Master List of Prioritized Planned Projects (“Master List”) included in Appendix A, *Map and List of Prioritized Projects*. City of Hayward prepared the Master List, which provides a final ranking and prioritizing of planned and potential projects, based on the automated scores derived in step 4 and the additional considerations described in section 2.2 below.

² All opportunity sites identified in step 2 were classified as GI projects. Based on information provided by local agencies in step 1, other classifications were assigned, where appropriate, to planned projects. Projects that were not classified as GI have co-benefits that may include GI.

Mapping of Planned and Potential Projects

The final identified planned GI projects are shown and summarized in Appendix A, *Map and List of Prioritized Projects*.

2.2 Summary of Prioritized Projects (Outputs of the GI Mechanism)

This section provides summary information regarding the development of outputs of the GI Mechanism included in Appendix A, *Map and List of Prioritized Projects*, including:

- Project Prioritization Criteria
- Master List of Prioritized Planned Projects
- Map of Implemented Projects and Project Opportunities

Prioritization Criteria

The list of potential GI project opportunities resulting from Steps 1-4 of the GI Mechanism (described in Section 2.1) resulted in a total of greater than 5,500 identified locations. To obtain consensus and initiate the GI Mechanism output screening and prioritization, a kick-off meeting was held with various City departments to identify City GI priorities. During the kick-off meeting, the City identified the characteristics of locations with lower feasibility and/or pollutant removal potential, as well as the characteristics of locations that would be considered high priority for GI retrofit. Locations with lower feasibility and/or pollutant removal potential were removed from the Master List based on the following identified characteristics:

- Parcels **not** owned by the City of Hayward or the following identified potential City Partners: Hayward Unified School District, Alameda Contra Costa Transit District, County of Alameda, East Bay Regional Park District, Hayward Area Recreation & Parks District (HARD), and San Francisco Bay Area Rapid Transit (BART);
- Parcels primarily located in new urban, open space area, and suburban residential areas;
- Parcels that represented easements, rail lines, state and federally owned land, Alameda County Flood Control District land, and San Francisco Bay lands;
- Freeways; and
- Local roads not located in high priority GI retrofit areas.

The remaining locations were characterized based on their location relative to high priority GI retrofit areas. High priority areas were identified as locations coincident with or adjacent to:

- HARD owned and maintained Parks;
- City of Hayward Bike and Pedestrian Master Plan improvements;
- City of Hayward Downtown Specific Plan boundary;
- Shoreline Master Plan boundary;
- Capital Improvement Program (CIP) Pavement Rehabilitation Projects;
- Main Street Improvement Project boundary;
- Potential New and Re- Development; or
- Identified Low-Income Housing Projects.

The resulting categorized potential public GI retrofit project list and map (approximately 2,000 remaining potential locations) were discussed with various City departments during a “GI Project Prioritization Meeting.” Based on feedback from the meeting, locations were screened for additional known feasibility constraints, resulting in removal of parcels <1.0 acres and ROWs with speed limits of 25 miles per gallon.

The resulting revised list of 244 parcels and 1,087 ROW segments with potential for public GI retrofit were reviewed in further detail by City to identify specific project opportunity locations that could potentially be constructed by 2020, 2030, or 2040.

Master List of Prioritized Planned and Potential Projects

The Master List of Prioritized Planned Projects (“Master List”), included in in Appendix A, *Map and List of Prioritized Projects*, is an output of Step 5 of the prioritization protocol described in Section 2.1, Approach for Prioritizing and Mapping Projects (GI Mechanism), using the prioritization criteria summarized in this section.

Through a detailed screening of the potential GI retrofit locations, the City identified a total of 5 parcels and 52 ROW segments that could potentially be constructed by 2020, 2030, 2040, or 2040+, should detailed feasibility assessments be favorable and funding be secured. These locations were grouped into thirteen (13) combined projects that are included in this GI Plan.

These thirteen (13) planned public GI retrofit projects are included in the Master List, which presents the following information regarding each project:

- Project name (for Parcels) or street name and segment cross-streets (for ROW);
- Property owner;
- Assessor’s parcel number (for parcels);
- Number of SWRP-identified ROW segments (for ROW projects);
- Total drainage area;
- Total impervious drainage area;
- Overlapping master/specific plans or other prioritization classification; and
- Anticipated construction year, should feasibility be favorable and funding be secured.

Map of Completed, Planned and Potential Projects

The map included in Appendix A, Implemented Projects and Project Opportunities, shows the locations of the thirteen (13) prioritized planned public GI retrofit projects as well as private and public MRP Provision C.3 Regulated Projects and non-C.3 Regulated Projects that were completed between 2003 and 2019. This map may be updated, as needed, to provide necessary information relative to the identification of funding options and consideration for potential inclusion of GI retrofit projects in the City of Hayward Recommended Capital Improvement Program list.

2.3 Impervious Surface Retrofit Targets

City of Hayward has identified targets for the amount of impervious surface, from public and private projects within its jurisdiction (including redevelopment projects regulated under Provision C.3.b of the MRP), to be retrofitted by 2020, 2030, 2040, and beyond 2040. The targets are presented in Table 2-1. The time schedules shown in this table are consistent with the timeframes for assessing load reductions for mercury and PCBs specified in Provisions C.11 and C.12 of the MRP.

To forecast private development for 2019/2020, 2021 through 2030, and 2031 through 2040, the City of Hayward participated in a process coordinated through the Alameda Countywide Clean Water Program (ACCWP). This process utilized the outputs of UrbanSim, a model developed by the Urban Analytics Lab at the University of California under contract to the Bay Area Metropolitan Transportation Commission (MTC). UrbanSim is a modeling system developed to support the need for analyzing the potential effects of land use policies and infrastructure investments on the development and character of cities and regions. The Bay Area's application of UrbanSim was developed specifically to support the development of Plan Bay Area, the Bay Area's Sustainable Communities planning effort.

MTC forecasts growth in households and jobs and uses the UrbanSim model to identify development and redevelopment sites to satisfy future demand. Model inputs include parcel-specific zoning and real estate data; model outputs show increases in households or jobs attributable to specific parcels. The methods and results of the Bay Area UrbanSim model have been approved by both MTC and ABAG Committees for use in transportation projections and the regional Plan Bay Area development process.

Table 2-1: Target Amounts of Existing Impervious Surface to be Retrofitted by 2020, 2030 and 2040

Year	Treated Area – Private Development ¹ (Impervious Acres)	Treated Area – Public CIP and GI Retrofit Projects included in this Plan (Impervious Acres)	Total Area ² (Impervious Acres)
By 2020	394.1	4.9	399.0
2021 - 2030	36.5	22.1	58.6
2031 - 2040	24.3	20.7	45.0
2040+	N/A	4.2	<i>To be determined</i>

1. Area developed or planned to be developed through City GI project tracking (for 2020), or projected to be developed by 2020, 2030 and 2040, as generated with the Bay Area UrbanSim model used by the Metropolitan Transportation Commission.

2. Includes Private Development Projections and Public CIP and GI Retrofit Projects.

City of Hayward is currently participating in a regional effort to perform a Reasonable Assurance Analysis that demonstrates how GI will be implemented to achieve PCB and mercury load reductions. To the extent that the implementation of this GI Plan may support load reductions for

mercury and PCBs, as outputs from the Regional Assurance Analysis become available, City of Hayward may consider modifying the targets presented in Table 2-1. Due to uncertainties related to the funding of public GI projects and the reliability of projections for private development projects, City of Hayward will track the progress toward achieving the targets presented in Table 2-1, identify any challenges that arise in achieving these targets, and propose solutions, in coordination with other MRP Permittees.

2.4 Early Implementation Projects

The following prioritized project has been identified as part of early implementation, in accordance with MRP Provision C.3.j.ii:

Project name: New 21st Century Library and Community Learning Center

Location: 777 C Street, Hayward, CA, 94541

Brief description: New 21st Century Library and Community Learning Center will be one of the largest net-zero energy public buildings in the country located at 888 C Street, Hayward, and offer users of all ages an expansive collection of reading, audio and visual materials. The three-story, 58,000-square foot building has been designed with high standards in environmental sustainability. In addition to being 100-percent energy self-sufficient and carbon-free, it will conserve drinking water by capturing, filtering and storing rainwater for non-potable uses such as flushing toilets and irrigation.

Part of the green infrastructure of the new 21st Century Library includes a rainwater catchment system located at the plaza. Rainwater harvested from the municipal parking garage, library roof top, C Street hardscape and plaza surfaces which is approximately 1.85 acre of impervious drainage, will be pumped into a 200,000 gallon storage cistern located underground in the old library basement. Filtered and treated water is used for irrigation for the plaza landscape as well as pumped to non-potable fixtures in the new library. Construction of the library is nearly complete. The work plan for completing construction is as follows:

- Summer 2019: Final inspections and sign-offs on permits
- October 2019: Grand Opening

2.5 GI Implementation in Private Developments

The City has the authority to require GI be incorporated into public and private development projects on a case-by-case basis. This requirement will be determined during the discretionary review and approval of proposed development projects through negotiations with project proponents and documented in either Conditions of Approval or within a Development Agreement. The inclusion of GI in the New 21st Century Library and Community Learning Center is one example of how GI, in addition to compliance with requirements for Regulated Projects (as described in MRP Provision C.3.b), has been included in projects during the Preliminary Engineering process, which could translate similarly into a development review process. The City will continue to work cooperatively with ACCWP to consider creating a policy that would require private development projects of a certain size to provide GI facilities to treat stormwater runoff from adjacent public streets. The City will consider developing an in-lieu fee program, in which

private development projects on constrained sites could pay a fee to fund the development of public GI projects for offsite treatment of a portion of the amount of runoff requiring treatment – as allowed under Provision C.3.e.i (Alternative or in-Lieu Compliance) of the MRP.

3. Tracking and Mapping Completed GI Projects

The process for tracking and mapping completed GI projects, both public and private, and making the information publicly available, as required by Provision C.3.j.i.(2)(d), is described below. This process was developed by the Alameda Countywide Clean Water Program (ACCWP), which participated in regional coordination with the Bay Area Stormwater Management Agencies Association (BASMAA), to comply with the requirement in Provision C.3.j.iv.(1) that “Permittees shall, individually or collectively, develop and implement regionally-consistent methods to track and report implementation of GI measures including treated area and connected and disconnected impervious area on both public and private parcels within their jurisdictions.”

3.1 Project Tracking and Load Reduction Accounting Tool

As a member agency of the ACCWP, the City of Hayward uses an ArcGIS online (AGOL) web application-based tool, the C3 Project Tracking and Load Reduction Accounting Tool (“AGOL Tool”), which ACCWP developed in cooperation with the Contra Costa Clean Water Program to assist its member agencies in meeting the requirements described above. Detailed information and instructions on the tool can be found in the C.3 Project Tracking and Load Reduction Accounting Tool Guidance Document (ACCWP 2017a).

The general process for entering GI projects into the AGOL Tool involves logging in to the ArcGIS online web application, opening the tool, and entering data. There are two methods for entering data, but, in general both involve: locating the project area, drawing the project boundary, entering project attributes, drawing the stormwater treatment facility(ies), and entering facility attributes. Project attributes include fields such as jurisdiction, location description, type of project, project name, and additional optional fields that can be populated if the information is known. Facility attributes include hydraulic sizing criterion, project ID, facility type, treatment, and percent of project area treated by the facility.

The City of Hayward has incorporated the use of the AGOL Tool into its processes for reviewing, approving and reporting MRP Provision C.3 Regulated Projects and non-C.3 Regulated projects that include GI – encompassing both public and private projects. The tool includes a feature for generating tables of C.3 Regulated Projects and GI projects that include MRP-required project data for annual reporting purposes.

3.2 Making Information Publicly Available

As required by the MRP, the process for tracking and mapping completed projects (public and private) includes making the information generated by the tool publicly available. Information from the tool will be made publicly available as follows.

- On an annual basis, include in the Annual Report for the City of Hayward’s Stormwater Program information from the tool in the form of (1) a list of GI projects (public and

private) that are planned for implementation during the permit term as required in Provision C.3.j.ii, and (2) a list of Regulated Projects approved during the fiscal year reporting period as required in MRP Provision C.3.b.iv.

- Coordinate with ACCWP to develop a viewable version of the AGOL tool, which is anticipated to be embedded on ACCWP's public website and may also be accessible via the City of Hayward's website.

4. Summary of General Guidelines for GI Projects

General Guidelines are presented in Appendix B to guide the City of Hayward in designing projects that have a unified, complete design that implements the range of functions associated with GI projects, and in providing for appropriate coordination of projects and project elements. The General Guidelines include hydraulic sizing guidance, standard specifications, and typical designs for GI projects. Additional information about the General Guidelines is summarized below.

4.1 Implementing Projects with a Unified, Complete Design

The General Guidelines presented in Appendix B focus on designing and coordinating projects that implement a range of functions appropriate to the type of project. For example, the guidelines for designing street projects address a range of functions including pedestrian travel, use as public space for bicycle, transit, vehicle movement, and locations for urban forestry. The guidelines for coordination identify measures for implementation during construction to minimize conflicts that may impact GI.

4.2 Hydraulic Sizing Requirements

Provision C.3.j.i.(2)(g) of the MRP states that GI projects are required to meet the treatment and hydromodification management (HM) sizing requirements included in Provisions C.3.c and C.3.d of the MRP. However, an exception to this requirement is provided in Provision C.3.j.i.(2)(g) for street projects that are not Regulated Projects under Provision C.3.b ("non-Regulated Projects").

The General Guidelines in Appendix B provide hydraulic sizing guidance for GI projects, addressing the hydraulic sizing criteria in MRP Provisions C.3.c and C.3.d, as well as the alternate sizing approach for constrained street projects developed by the Bay Area Stormwater Management Agencies Association. These guidelines do not address Regulated Projects as defined in Provision C.3.b of the MRP.

Please note that some non-Regulated Projects are required to implement site design measures in accordance with Provision C.3.i of the MRP. Appendix L of the C.3 Technical Guidance explains how to determine whether Provision C.3.i applies to your project, and how to incorporate applicable site design measures, if required.

Table 4-1 presents a summary of which documents provide hydraulic sizing guidance, and other applicable guidance, for different types of projects.

Table 4-1: Where to Find Hydraulic Sizing Guidance and Other Guidance - by Project Type

Type of Project	Where to Find Guidance	
	Provision C.3.i or HM Guidance, if Applicable	Hydraulic Sizing Guidance
Non-Regulated Green Infrastructure Project (public or private project) that is NOT subject to Provision C.3.i ³	Not applicable	Appendix B – <i>General Guidelines for GI Projects</i>
Non-Regulated Green Infrastructure Project (public or private project) that IS subject to Provision C.3.i	ACCWP C.3 Technical Guidance (Appendix L, Site Design Requirements for Small Projects)	
Regulated Project that is NOT a Hydromodification Management (HM) Project ⁴	Not applicable	ACCWP C.3 <i>Technical Guidance</i> (Section 5.1, Hydraulic Sizing Criteria)
Regulated Project that IS an HM Project	ACCWP C.3 Technical Guidance (Chapter 7, Hydromodification Management Measures)	

4.3 Standard Specifications and Typical Designs

Appendix B of this GI Plan also includes typical design drawings and standard specifications for GI projects, which address various types of land-use, transportation, and site characteristics. GI projects may also utilize design guidance provided in Chapter 6 of the C.3 Technical Guidance manual (ACCWP 2017b) for other types of low impact development storm water treatment facilities, subject to municipal staff approval.

³ MRP Provision C.3.i applies to projects that create and/or replace at least 2,500 but less than 10,000 square feet of impervious surface; and Individual single-family home projects that create and/or replace 2,500 square feet or more of impervious surface.

⁴ An HM Project is a Regulated Project that creates and/or replaces one acre or more of impervious surface, will increase impervious surface over pre-project conditions, and is located in a susceptible area, as shown on the ACCWP default susceptibility map.

5. GI Requirements in Other Planning Documents

Over the last several years, the City of Hayward has updated planning documents that affect the alignment, configuration and design of impervious surfaces within its jurisdiction, including streets, parking lanes, parking lots, sidewalks, curb extensions, plazas, public open spaces, and drainage infrastructure. These documents are listed and summarized below.

- Hayward General Plan 2040: Natural Resources Element (2014)
- Hayward General Plan 2040: Public Facilities and Services Element (2014)
- Hayward Downtown Specific Plan (2019b)

5.1 Summary of Updated Planning Documents

The planning documents listed were updated to include requirements for the use of GI, low-impact development (LID), and other types of landscape-based stormwater facilities, as described in more detail below.

Hayward General Plan 2040: Natural Resources Element: In order to protect surface and groundwater resources from contaminants, this General Plan Element promotes stormwater management techniques that minimize surface water runoff and impervious ground surfaces in public and private developments, including the use of LID techniques to manage stormwater.

Hayward General Plan 2040: Public Facilities and Services Element: In order to accommodate runoff from existing and future development, prevent flooding, and improve environmental quality, this General Plan Element encourages GI design and LID techniques for stormwater facilities (i.e., using vegetation and soil to manage stormwater) to achieve multiple benefits (e.g., preserving and creating open space, improving runoff water quality).

Hayward Downtown Specific Plan: This plan highlights the requirements under Provision C.3 of the MRP, includes specific GI opportunity sites throughout the Plan Area and specific GI designs for the right-of-way, describes the City's policy to evaluate capital projects for incorporation of GI and treatment measures (including non-C.3 regulated projects), and generally recommends prioritizing stormwater treatment for vehicular surface areas in order to address runoff with high pollutant loads.

5.2 Anticipated Updates of Additional Planning Documents

The City of Hayward has identified an additional need to include GI requirements in the City's Bicycle and Pedestrian Master Plan update that is currently being developed and is anticipated to be completed in Fiscal Year 2019/20. More detailed information on the Bicycle and Pedestrian Master Plan update can be found in the *Workplan to Incorporate Green Infrastructure Requirements in City of Hayward's Bicycle and Pedestrian Master Plan Update*, included as Appendix C.

Currently, there are no scheduled updates of other planning documents that could potentially include GI requirements. In the future, as schedules, scopes of work, and budgets are developed for planning document updates, the City will consider incorporating additional GI requirements in the Hayward General Plan and Downtown Specific Plan, and other planning documents such as the Complete Streets Strategic Initiative.

6. Evaluation of Funding Options

The City of Hayward has evaluated the following funding options for implementing prioritized GI projects:

- Alternative Compliance funds such as in-lieu fees and credit trading programs;
- Grant monies, including resource-based grants and transportation grants;
- Realignment of existing services, including potential opportunities for wastewater, refuse collection, and/or water fees to fund aspects of stormwater compliance;
- New tax or other levies, including parcel taxes, business license taxes, vehicle license fees, sales taxes, utility users taxes, transient occupancy taxes, general obligation bonds, regulatory fees, development impact fees, and property-related fees (including the potential to adopt property-related fees without going to ballot as allowed by Senate Bill 231);
- Funds from the Clean Water State Revolving Loan Program;
- Special Financing Districts, including benefit assessments, community facilities districts, business improvement districts, and enhanced infrastructure financing districts;
- Partnerships, including those with multiple public agencies, Caltrans, private entities, and volunteers.

6.1 Evaluation Criteria

The funding options were evaluated using the following criteria:

- **Ballot approval** – Based on local experience, options requiring ballot approval may be considered if GI were included in an initiative to fund a program of other improvements for the community.
- **Reliability** – Implementing a GI program will require sources of ongoing funding.
- **Cost to implement** – In general, options with lower implementation costs would be preferred.
- **Suitability** – Depending on the types of projects included in the GI Plan, some types of funding may be suitable. For example, because the GI Plan is anticipated to include active transportation projects, some transportation funding sources may be suitable.
- **Obstacles** – As each potential funding source was considered, the potential for additional obstacles was reviewed.

6.2 Recommendations

As a result of the evaluation of funding options, the following funding options have been recommended for further study, based on the criteria described above:

- **Grants** – Both transportation and resource-based grants may be applicable for projects included in the GI Plan, including the State Water Resources Control Board's Proposition 1 Stormwater Grant Program, Caltrans' Active Transportation Program, and the One Bay Area Grant Program administered by the Alameda County Transportation Commission.

- **Volunteers** – The City is interested in exploring opportunities for volunteers to participate in GI implementation and maintenance, possibly through local industries, colleges, and/or schools; the Keep Hayward Clean & Green Task Force; and/or expanding the Adopt a Block program to include an Adopt a GI Project program.
- **Stormwater Fee** – Hayward has existing stormwater fee but it hasn't been increased in some time. The City Council could potentially consider increasing the fee to address GI as well as other stormwater needs.
- **Alternative Compliance** – As described in Section 2.5, Green Infrastructure in Private Developments, City staff will consider developing an in-lieu fee program for C.3 Regulated Projects that have constraints for implementing on-site stormwater treatment.
- **Multi-Agency Partnerships** – Hayward Unified School District would be a potential partner after the State Water Resources Control Board includes school districts in the statewide Phase II Stormwater Permit. Other potential partners are Chabot Community College and the Hayward Area Recreation District.
- **Caltrans Mitigation** – The City is partnering with Caltrans on trash mitigation and will explore expanding this partnership to include GI.
- **Transportation Partnerships** – There may be opportunities to partner with BART to implement GI projects within the City.
- **Landscape and Lighting Fee:** GI maintenance could potentially be funded by an increase in the Landscape and Lighting Fee. This would be part of a ballot measure and could cover maintenance of GI.
- **Regulatory Fees** – There may be potential to recover costs for GI administration through standard permit application fees.

7. References

Alameda Countywide Clean Water Program. 2017a. C3 Project Tracking and Load Reduction Accounting Tool Guidance Document.

Alameda Countywide Clean Water Program. 2017b. C.3 Technical Guidance Manual, Version 6.

Alameda Countywide Clean Water Program. 2019. Example Typical Green Infrastructure Details.

City of Hayward, California. 2014. Hayward General Plan 2040.

City of Hayward, California. 2019a. City of Hayward's Bicycle & Pedestrian Master Plan (website).

City of Hayward, California. 2019b. Hayward Downtown Specific Plan – Public Hearing Draft.

Geosyntec. 2017. Alameda Countywide Stormwater Resource Plan Screening and Prioritization using Multi-Benefit Metrics Technical Memorandum. December 13.

National Association of City Transportation Officials. 2017. Urban Street Stormwater Guide.

San Francisco Bay Regional Water Quality Control Board. 2015. Order No. R2-2015-0049, Municipal Regional Stormwater Permit (MRP).

San Mateo Countywide Water Pollution Prevention Program. 2009. San Mateo County Sustainable Green Streets and Parking Lots Design Guidebook.

This page intentionally left blank

Appendix A. Map and List of Prioritized Projects

This page intentionally left blank

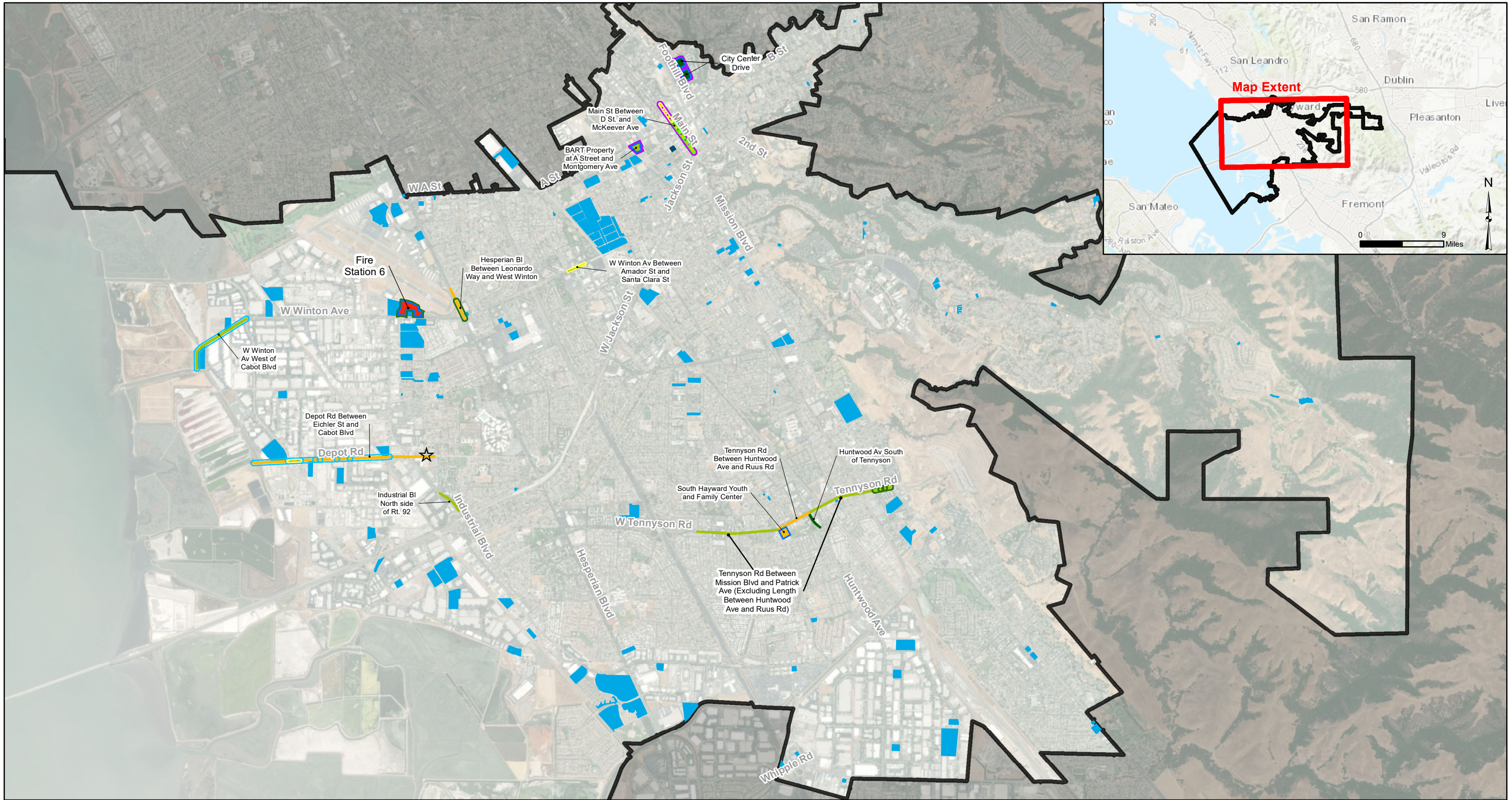

Legend

<p>Actual New/Re-Development with GI, AGOL 2003-2019</p> <ul style="list-style-type: none"> Private (122) Public (1) <p><i>Note: Project count indicated next to anticipated construction year category.</i></p>	<p>Identified Public GI Retrofit Projects</p> <ul style="list-style-type: none"> 2020 Identified Project (1) 2030 Identified Project (5) 2040 Identified Project (5) 2040+Potentially Project (2) 	<p>City Master and Specific Plan Overlap</p> <ul style="list-style-type: none"> Shoreline Master Plan Downtown Specific Plan Bike/Ped Master Plan Main St Improvement 	<p>GI Project Type</p> <ul style="list-style-type: none"> Regional Opportunity Adjacent to Proposed New or Redevelopment ☆ Affordable Housing Project Location
---	--	---	--

**Hayward GI Plan
Implemented Projects and Project Opportunities**
City of Hayward, California

Geosyntec
consultants

LA0513 July 2019

**Figure
1**

City of Hayward GI Plan

Appendix A

Master List of Prioritized Planned Projects

Project Name	Project Type	Parcel Property Owner	Assessor's Parcel Number	Number of SWRP-Identified ROW Segments Included in Combined Project	Total Drainage Area (acres)	Total Impervious Drainage Area (acres)	Overlapping Master/Specific Plans or Other Prioritization Classification	Anticipated Construction Year
Fire Station 6	Parcel	City of Hayward	432 012400200 & 432 012400104	n/a	6.9	4.3	Bike/Ped Master Plan (within 50-ft)	2020
South Hayward Youth and Family Center	Parcel	City of Hayward	465 000100904	n/a	2.4	1.1		2030
Depot Rd Between Eichler St and Cabot Blvd	ROW	n/a	n/a	9	17.3	12.4	Shoreline Master Plan	2030
Hesperian Bl Between Leonardo Way and West Winton	ROW	n/a	n/a	3	3.4	2.2	Bike/Ped Master Plan	2030
Main St Between D St. and McKeever Ave	ROW	n/a	n/a	6	6.2	4.0	Downtown Specific Plan, Main St Improvement, Bike/Ped Master Plan	2030
Tennyson Rd Between Huntwood Ave and Ruus Rd	ROW	n/a	n/a	5	4.0	2.4		2030
BART Property at A Street and Montgomery Ave	Parcel	San Francisco Bay Area Rapid Transit	428 004605202	n/a	1.9	1.4	Downtown Specific Plan, Bike/Ped Master Plan (within 50-ft)	2040
Industrial Bl North side of Rt. 92	ROW	n/a	n/a	3	4.0	2.6		2040
Tennyson Rd Between Mission Blvd and Patrick Ave (Excluding Length Between Huntwood Ave and Ruus Rd)	ROW	n/a	n/a	23	18.2	11.2	Bike/Ped Master Plan	2040
W Winton Av Between Amador St and Santa Clara St	ROW	n/a	n/a	1	1.8	1.1		2040
W Winton Av West of Cabot Blvd	ROW	n/a	n/a	1	8.6	4.4	Shoreline Master Plan	2040
City Center Drive	Parcel	City of Hayward	415 025011300 & 415 025011102	n/a	4.4	3.1	Downtown Specific Plan, Bike/Ped Master Plan (within 50-ft)	2040+
Huntwood Av South of Tennyson	ROW	n/a	n/a	1	1.8	1.1		2040+

Appendix B. General Guidelines for GI Projects

These General Guidelines have been developed to guide the City of Hayward in designing a project that has a unified, complete design that implements the range of functions associated with green infrastructure (GI) projects, and in providing for appropriate coordination of projects and project elements. The guidelines apply to projects that incorporate GI into an existing roadway segment or a previously developed public parcel and are **not** Regulated Projects as defined in Provision C.3.b of the Municipal Regional Stormwater Permit (MRP). The guidelines are organized as follows.

Section B.1	Functions Associated with GI
Section B.2	Guidelines for GI Retrofits of Existing Streets
Section B.3	Guidelines for GI Retrofits of Public Parcels
Section B.4	Guidelines for Coordination of Projects
Attachment B-1	Hydraulic Sizing Requirements
Attachment B-2	Worksheet for Calculating the Combination Flow and Volume Method
Attachment B-3	Mean Annual Precipitation Map of Alameda County
Attachment B-4	Standard Specifications and Typical Designs
Attachment B-5	Model Sign-off Form for Capital Improvement Projects
Attachment B-6	Guidance for Sizing Green Infrastructure Facilities in Street Projects

B.1 Functions Associated with GI

The functions associated with GI retrofits of existing streets and GI retrofits of public parcels are identified below.

B.1.1 Functions Associated with GI Retrofits of Existing Streets

The following functions are associated with GI retrofits of existing streets:

- Street use for stormwater management, including treatment;
- Safe pedestrian travel;
- Use as public space for bicycle, transit, and vehicle movement/parking; and
- Use as locations for urban forestry.

B.1.2 Functions Associated with GI Retrofits of Public Parcels

Existing facilities on public parcels may be retrofitted with GI. Although there are potentially a wide range of public uses that could occur on various parcels, key issues are associated with the outdoor use of public parcels for landscaping and parking. The following functions are associated with GI retrofits of public parcels:

- Site use for stormwater management and landscaping
- Circulation and parking within the site

B.2 Guidelines for GI Retrofits of Existing Streets

Streets must perform the range of functions described in Section B.1.1. The following guidelines provide general guidelines for designing and constructing GI facilities within the right-of-way of existing streets, to address the full range of functions. Additional design guidance for GI facilities, which are also referred to as low impact development (LID) stormwater treatment facilities, is provided in Chapters 5 and 6 of the Alameda Countywide Clean Water Program's (ACCWP's) C.3 Technical Guidance, which may be downloaded at, www.cleanwaterprogram.org (click Businesses, then Development).

B.2.1 Guidelines Addressing Street Use for Stormwater Management

The GI guidelines to support street functionality for stormwater management are organized around the following objectives:

- Convey stormwater to GI facilities,
- Identify the appropriate GI typical designs for the project, and
- Convey stormwater away from transportation facilities.

Convey Stormwater to GI Facilities

GI retrofits of existing streets must be designed to convey stormwater runoff from the roadway surface to the proposed GI facilities. Key issues include working with the street profile, working with the existing drainage system, and considering conveyance facilities where needed.

Work with the Existing Street Profile

Modifying the profile of an existing street is costly. Therefore, the designs of GI street retrofits should generally maintain the existing street profile where feasible. The street profile affects how stormwater runoff flows off of a street, and is considered in the design of GI facilities. The most common street profile is crowned, although some streets may be reverse crowned, or may drain to one side, as illustrated in Figures B-1 through B-3. Occasionally, a street may have a flat profile, such as the example shown in Figure B-4 in which a street is designed to drain into pervious pavement. Unless pervious pavement is used for the full width of the street, GI facilities would be located downslope from the roadway surface. In a crowned street, which is most common throughout the City of Hayward, this may allow for GI facilities on both sides of the street (see also Figure B-5, which is from Hayward's Downtown Specific Plan). In a reverse crowned street, GI facilities may be considered in the median; and in a side-sloping street, GI facilities would be located on the downslope side.

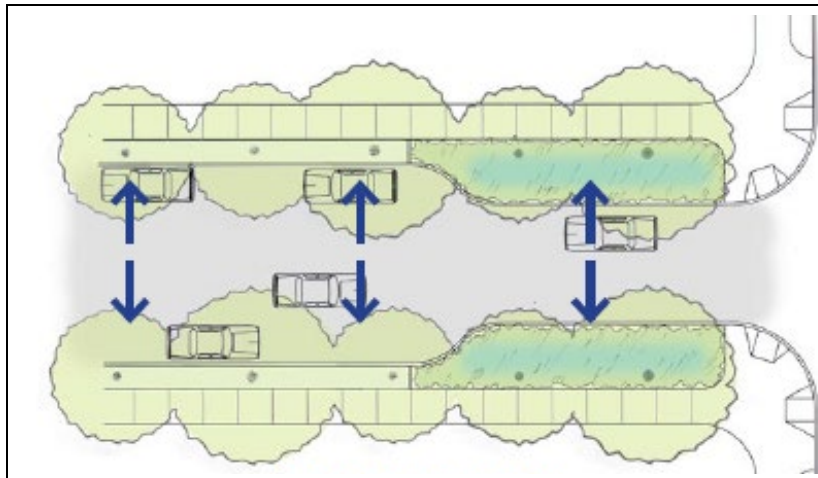

Figure B-1. Crowned Street Profile. A crowned street is designed so that the highest elevation is in the middle of the street, such that stormwater runoff drains to the sides of the street. GI facilities may be located on either side of the street.

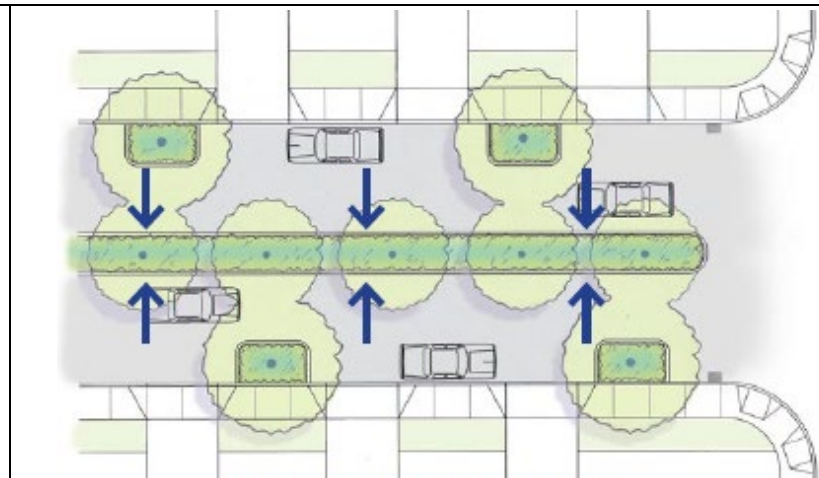

Figure B-2. Reverse Crowned Street Profile. A reversed crowned street is the opposite of a crowned street and directs runoff to the center line of the street. GI facilities may be considered in the median.

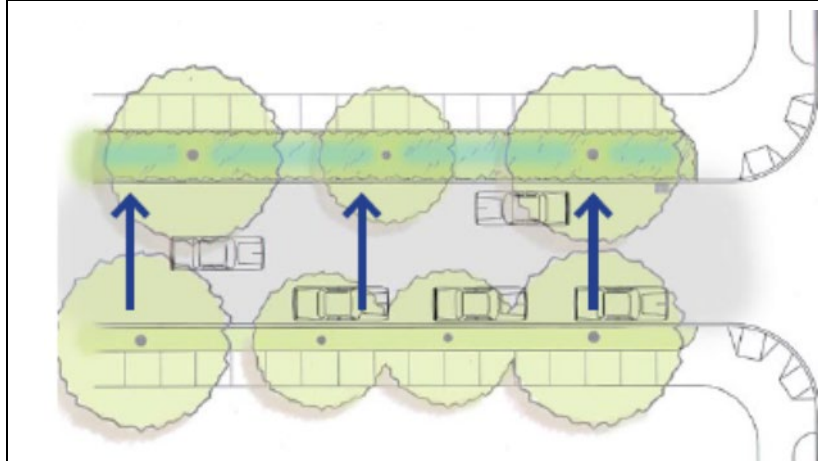

Figure B-3. Side Shed Street Profile. Side shed streets are designed to shed all water to one side of the street. GI facilities would be located on the downslope side.

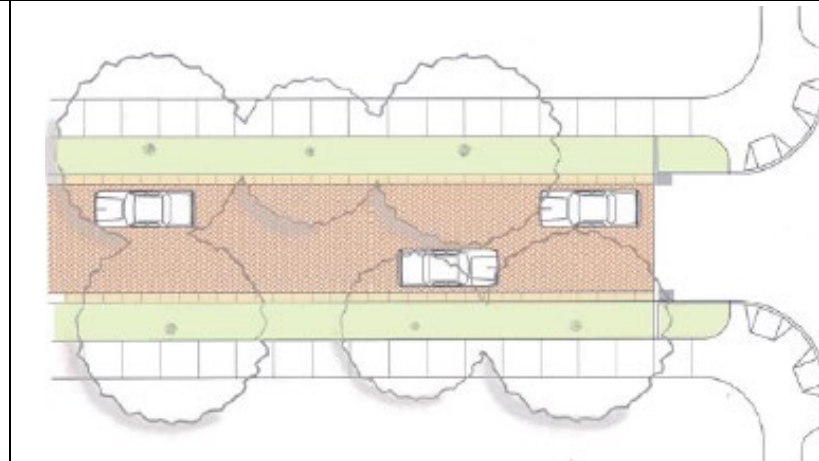

Figure B-4. Flat Street Profile. Flat streets are designed to drain through pervious paving. While these facilities do not have a marked slope, they may be graded slightly so that they drain to the sides or center of the street when there is too much water.

Source: San Mateo Countywide Water Pollution Prevention Program/Nevue Ngan

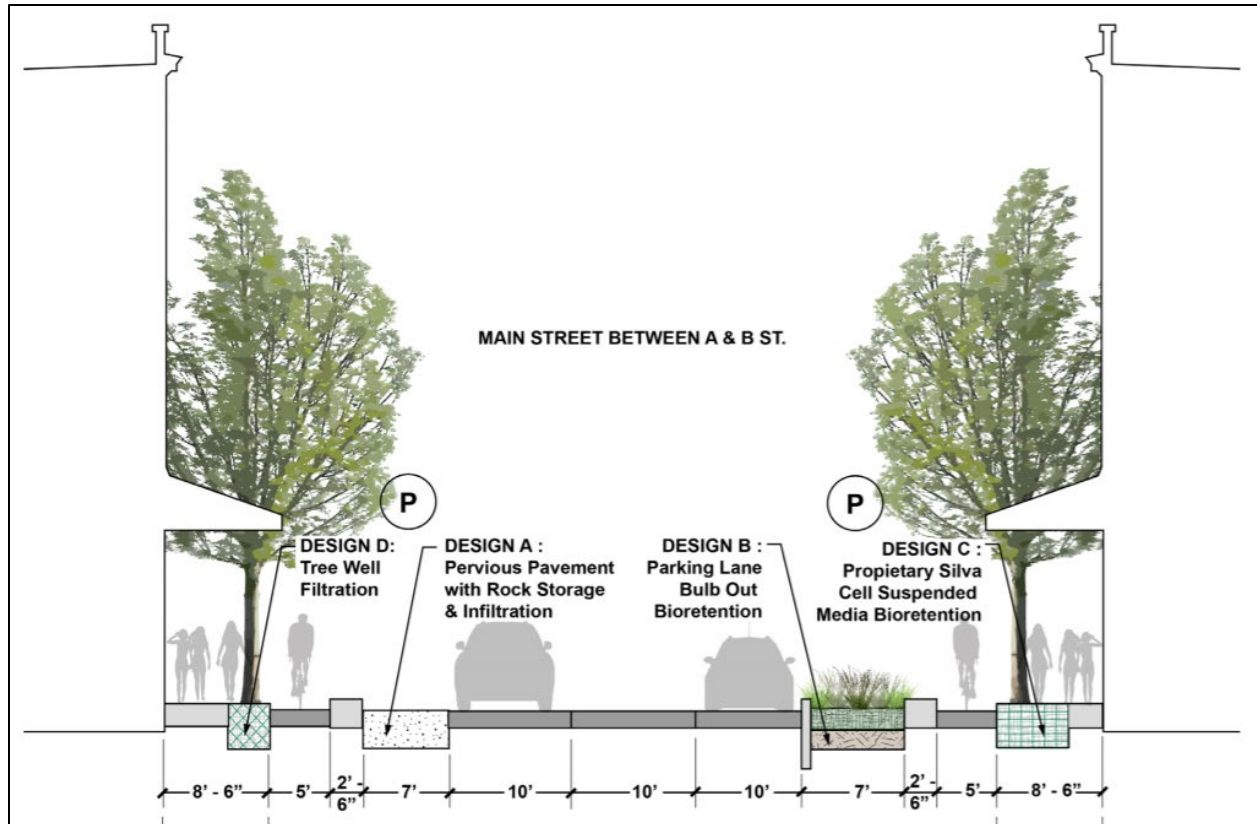

Figure B-5. Downtown Hayward Main Street Typical Section. The typical section for Main Street in Downtown Hayward is a 76-foot right-of-way with a mirrored section of 8.5-foot sidewalk, 5-foot bike lane, 2.5-foot passenger landing, 7-foot parking area and a 10-foot traveled lane. In addition, there is a middle 10-foot two-way turning lane. This section assumes a crowned roadway with the high point in the center of the turning lane.

Source: Hayward Downtown Specific Plan

Work with the Existing Drainage System

If an underdrain will be included in the GI facility design, a street retrofit site should have an existing storm drain line, to which the underdrain may be connected. If there is no existing storm drain line, subject to municipal approval, in lieu of an underdrain, sites with poorly draining soils may potentially be designed with an oversized reservoir layer of rock below the GI facility. The rock layer would be sized to hold the amount of runoff identified in Attachment B-1, Hydraulic Sizing Criteria. This approach was used in the City of Burlingame’s Donnelly Street green street project (Figure B-6), because there was no available storm drain line.

Figure B-6. Donnelly Street Green Street Project. The Donnelly Street Green Street Project includes a rain garden, pictured at right, which captures runoff from the adjacent commercial buildings and parking lot. The rain garden was designed with no underdrain and an enlarged subsurface layer of rock, which serves as a reservoir and allows runoff to slowly infiltrate to the underlying soil. The system was designed for onsite management of flows that exceed the 30-year storm. An overflow to the curb is provided for a 50- to 100-year event scenario.

Source: City of Burlingame



Consider Conveyance Facilities

In some cases, a street retrofit project may be located near an appropriate site for a larger stormwater facility than can be accommodated in the typical street right-of-way. For example, a street retrofit project may be designed to convey stormwater runoff to a bioretention facility that will be constructed on an adjacent park or greenway. This approach is illustrated by the City of El Cerrito's Ohlone Greenway Natural Area and Rain Garden project's incorporation of a rain garden (Figure B-7) that captures and treats stormwater runoff from an adjacent segment of Fairmont Boulevard. Various methods may be considered for conveying runoff to nearby GI facilities, including trench drains (Figure B-8) and vegetated swales or vegetated channels (Figure B-9).

Figure B-7. Ohlone Greenway Natural Area and Rain Garden. This rain garden captures and treats runoff from an adjacent segment of Fairmont Boulevard. In this instance, the rain garden location provided an opportunity to convey and treat stormwater outside the street right-of-way.

Source: PlaceWorks



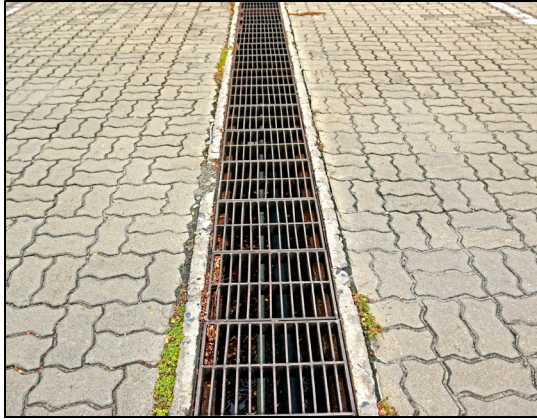

Figure B-8. Trench Drain. A trench drain can be used to convey runoff to GI facilities.



Figure B-9. Pervious Drainage Channel. Pervious, unlined drainage channels can be designed to convey runoff to GI facilities.

Identify the Appropriate Typical Design for Street Project Site

Refer to Attachment B-4 of this appendix to identify appropriate typical design drawings for the project. Typical designs have been developed for various conditions that may occur at a project site. GI projects may also utilize design guidance provided in Chapter 6 of the C.3 Technical Guidance manual for other types of low impact development storm water treatment facilities, subject to municipal staff approval.

Apply the Appropriate Hydraulic Sizing Criteria

Refer to Attachment B-1 for guidance on identifying and using the appropriate hydraulic sizing criteria for the proposed project.

Convey Stormwater away from Transportation Facilities

To manage the risk of flooding, adequate drainage facilities must be provided for all segments of roadway, in accordance with the City of Hayward's storm drainage design standards, including design criteria, standards, policies, and procedures for storm drainage improvements. All storm drainage facilities must be designed in accordance with the applicable standards and accepted engineering principles, as directed by the City of Hayward's Department of Public Works.

B.2.2 Guidelines Addressing Pedestrian Travel within Street Right of Way

To help reduce pollution from automobiles, the City of Hayward has a goal to improve and expand transportation choices, including the pedestrian mode of travel. As part of meeting this goal, the design of GI retrofits of existing streets should incorporate measures that seek to enhance the safety and attractiveness for pedestrians. The following measures may be considered:

- Within the Plan Area identified by the Downtown Specific Plan, include stormwater treatment measures within the public realm in currently planned traffic calming and vehicular routing right-of-way (ROW) improvements that will make the Downtown Plan Area more accessible for pedestrians and cyclists, while continuing to accommodate automobile use.
- Incorporate into project intersections curb extensions, also referred to as bulbouts, which reduce the street width at intersections and shorten the length of street crossings for pedestrians, while also providing space for GI facilities (see Figure B-10).
- Provide attractive landscaping designs that enhance the sense of place for pedestrians and may potentially include amenities such as shade trees and seating areas.
- Locate the GI facility between the sidewalk and vehicle travel lanes, in order to enhance pedestrian safety by providing protected sidewalks.



Figure B-10. Curb Extension. In addition to reducing the street width and shortening the length of street crossings for pedestrians, curb extensions, or “bulbouts,” such as this example in Albany, also provide space for GI facilities.

Source: bluegreenbldg.org

B.2.3 Guidelines Addressing Street Use for Bicycle, Transit, and Vehicle Movement/Parking

Complete streets balance the needs of pedestrian, bicycle, automobile, and public transit modes of travel. To meet the goal of improving and expanding transportation choices, described in Section B.2.2, in addition to pedestrian transportation, GI retrofits of existing streets must also be designed to accommodate bicycles, motor vehicles, and, where appropriate, public transit. The design and construction of each GI project should incorporate appropriate measures to enhance transportation safety and help improve the attractiveness of alternative modes of travel. The following measures may be considered:

Bicycle-Friendly Measures

- Include bicycle lanes in GI retrofits of existing streets.
- Provide a protected bicycle lane by locating a GI facility or other landscaped area, or a lane of parking, between a bicycle lane and lanes of motor vehicle travel.
- Include bicycle racks in GI street retrofit projects.

Public Transit-Friendly Measures

- Enhance the comfort of public transit users by providing shelter, shade, and greenscape at bus stops and other public transit stops.
- Integrate GI into transit facilities, such as boarding bulbs and islands, or rooftops of transit shelters.
- Provide bicycle racks at public transit stops.

Motor Vehicle-Friendly Measures

- Implement GI with geometric changes that reduce vehicle speed and/or improve visibility. This may include “road diet” projects that reduce the number of lanes of travel, or traffic calming projects that incorporate areas of landscaping, such as traffic islands, as visual cues to help slow down traffic.
- Provide visual cues to help slow down traffic and alert drivers to the presence of GI facilities, to help prevent motor vehicles from driving into a stormwater facility. Visual cues may include curbs and landscaping that is readily visible to drivers.
- Within the Plan Area identified by the Downtown Specific Plan, construct parking lanes with pervious pavement underlain with a pervious storage material to treat runoff from vehicular lanes.

B.2.4 Guidelines Addressing Urban Forestry in Public Right of Way

Increasing the planting of street trees in the City of Hayward is anticipated to benefit local water quality, air quality, energy efficiency, and property values. GI projects should incorporate measures to preserve existing street trees and promote the planting of new street trees. The following measures should be incorporated, as appropriate:

- Prioritize the preservation of existing mature trees.
- Replace any mature trees that are removed by the project.
- Maximize the planting of new street trees, consistent with the City's General Plan's Natural Resources Element, Goal NR-4.12: Urban Forestry, which encourages the planting of native and diverse tree species to reduce heat island effect, reduce energy consumption, and contribute to carbon mitigation.
- The planting of trees within a GI facility should follow applicable guidance, including the identification of appropriate species, provided in Appendix B of the ACCWP C.3 Technical Guidance, which may be downloaded at www.cleanwaterprogram.org (click Businesses, then Development).

B.3 Guidelines for GI Retrofits of Public Parcels

Public parcels must perform the range of functions described in Section B.1. The following guidelines provide general guidelines for GI retrofitting of public parcels, to address the full range of functions. Additional design guidance for GI facilities, which are also referred to as LID storm water treatment facilities, is provided in Chapters 5 and 6 of the ACCWP C.3 Technical Guidance, which may be downloaded at, www.cleanwaterprogram.org (click Businesses, then Development).

B.3.1 Guidelines to Address Parking Lot Use for Landscaping and Stormwater Management

Parking lots often contain excess parking spots and oversized parking spaces and drive aisles. GI retrofits of public parcels should consider options to reduce any unnecessary parking areas, in order to provide space for landscaping, stormwater management, and pedestrian walkways. The following measures may be considered:

Maximize Space for GI and other Landscaping

To allow more space for GI and other landscaping, the City may consider modifying or allowing exceptions to the City's parking lot standard. Parking should be designed to meet "average day" needs and utilize pervious overflow parking zones to meet peak parking needs.

Consider Specifying Pervious Paving

Pervious paving may be used in parking lot designs. Where pervious paving is underlain with pervious soil or pervious storage material sufficient to hold the Municipal Stormwater Regional Permit Provision C.3.d volume of rainfall runoff, it is not considered impervious and can function as a self-treating area. Please see Section 6.6 of the C.3 Technical Guidance for further design guidance for pervious pavement installations.

Convey Stormwater to GI Facilities

GI retrofits of existing sites must be designed to convey stormwater runoff from impervious surfaces (roofs and/or parking lots) to the proposed GI facilities. Key issues include working with the existing drainage system, and considering conveyance facilities where needed.

Work with the Existing Drainage System

If an underdrain will be included in the GI facility design, the site should have access to an existing storm drain line, to which the underdrain may be connected. If there is no existing storm drain line, subject to municipal approval, in lieu of an underdrain, sites with poorly draining soils may potentially be designed with an oversized reservoir layer of rock below the GI facility. The rock layer would be sized to hold the amount of runoff identified in Section 6, Hydraulic Sizing Requirements. This approach was used in the City of Burlingame's Donnelly Street green street project (Figure B-5), because there was no available storm drain line.

Consider Conveyance Facilities

Various methods may be considered for conveying runoff from impervious surfaces to GI facilities, including trench drains (Figure B-7) and vegetated swales or vegetated channels (Figure B-8). In parking lots that include speed bumps, consider using speed bumps to help direct stormwater runoff to GI facilities.

Identify the Appropriate Typical Design for the Project Site

Refer to Attachment B-4, included in this appendix, to identify appropriate typical design drawings for the project. Typical designs have been developed for various conditions that may occur at a project site. GI projects may also utilize design guidance provided in Chapter 6 of the C.3 Technical Guidance manual for other types of low impact development storm water treatment facilities, subject to municipal staff approval.

Apply the Hydraulic Sizing Criteria Identified in Provisions C.3.c and C.3.d

Refer to Attachment B-1 for guidance on using the appropriate hydraulic sizing criteria in MRP Provisions C.3.c and C.3.d as applicable to design GI projects that are not regulated by Provision C.3.b ("non-Regulated Projects).

Prioritize Tree Preservation and Planting

In order to benefit local water quality, air quality, energy efficiency, and property values, GI projects on public parcels should incorporate measures to preserve existing street trees and promote the planting of new trees. The following measures should be incorporated, as appropriate:

- Prioritize the preservation of existing mature trees.
- Replace any mature trees that are removed by the project.
- Preserve and protect trees, consistent with the City's General Plan's Natural Resources Element, Goal NR-1.7 Native Tree Protection, which encourages protection of mature, native tree species to the maximum extent practicable, to support the local eco-system, provide shade, create windbreaks, and enhance the aesthetics of new and existing development.
- Incorporate trees in landscaped areas within parking lots – which serves to shade vehicles and paved surfaces, improve air and water quality, intercept stormwater in the tree canopy, and take up stormwater through the root system.
- The planting of trees within a GI facility should follow guidance, including the identification of appropriate species, provided in Appendix B of the ACCWP C.3 Technical Guidance, which may be downloaded at www.cleanwaterprogram.org (click Businesses, then Development).

B.3.2 Guidelines to Address Parking Lot Use for Vehicular Parking

GI retrofits of public parcels should provide for adequate motor vehicle and bicycle parking for the proposed public use. The following measures may be considered:

- Include bicycle parking facilities.
- Provide pedestrian walkways within parking lots (Figure B-11 shows how a pedestrian walkway was included alongside a bioretention facility in Alameda County's Turner Court facility, located in Hayward). Consider including bridged walkways across GI facilities.
- Provide safe pedestrian access to and directional signage for adjacent public transit stops.
- Consider other improvements to enhance existing pedestrian circulation and safety.

Depending on the type of use, larger public parcel retrofits should consider providing bicycle storage, changing rooms, and preferred parking for carpooling



Figure B-11. Turner Court Bioretention Area. A walkway provides pedestrian access to Alameda County's Turner Court facility from the adjacent City street in the City of Hayward. The pedestrian walkway is adjacent to a bioretention area that treats stormwater runoff from the Turner Court facility's parking lot.

Source: Alameda County Public Works Agency

B.4 Guidelines for Coordination of Projects

Installing GI components at a project prior to the completion of that project, or having GI components in place during the construction of an adjacent project, has the potential to degrade the functioning of the GI facility. Street improvement or other infrastructure projects, the development of public parcels, and other public and private projects should therefore include coordination of construction schedules to minimize impacts to GI.

The following measures shall be implemented in all GI projects to protect investments in GI:

1. GI facilities shall not be used as temporary sediment basins during construction.
2. Erosion control plans shall include protections for GI; project-specific erosion controls are included in the Alameda Countywide Clean Water Program Stormwater Requirements Checklist. Erosion control plans are reviewed as part of the City of Hayward's grading permit process.
3. Installed GI facilities shall be protected from construction runoff and kept offline until the contributing drainage area is stabilized.

Contractors are encouraged to construct GI facilities at the end of a project, to help protect the facilities from construction-related impacts.

Attachment B-1: Hydraulic Sizing Criteria

This Attachment to the City of Hayward's Green Infrastructure (GI) Plan provides guidance on the following topics:

- Hydraulic sizing criteria in MRP Provisions C.3.c and C.3.d as applicable to GI projects that are not regulated by Provision C.3.b ("non-Regulated Projects)
- Alternate sizing approach for constrained street projects

B1.1 Hydraulic Sizing Criteria in MRP Provisions C.3.c and C.3.d

Provision C.3.c requires the use of low impact development (LID) stormwater controls. To meet the MRP definition of LID, bioretention facilities must have a surface area no smaller than what is required to accommodate a 5 inches/hour stormwater runoff surface loading rate, and infiltrate runoff through biotreatment soil media at a minimum of 5 inches per hour.

Provision C.3.d of the Municipal Regional Stormwater Permit (MRP) includes volume-based, flow-based, and the combination volume-and flow-based hydraulic sizing criteria. Bioretention areas may be sized using a simplified flow-based hydraulic sizing method, known as the "4 percent method," in which the surface area of the bioretention area is sized at 4 percent of the effective impervious surface area that is treated. However, by using a combination volume- and flow-based hydraulic sizing approach, it may be possible to provide a bioretention area that is less than 4 percent of the effective impervious surface area, which can help reduce costs. Step-by-step instructions for using the 4 percent method and the volume-based sizing criteria are provided in Section 5.1 of the C.3 Technical Guidance. Guidance for using the combination flow and volume criteria from Section 5.1 of the C.3 Technical Guidance document are copied below. The worksheet for using this method is provided in Attachment B-2.

The implementation of LID stormwater treatment facilities designed in accordance with Provisions C.3.c and C.3.d of the MRP will provide hydromodification management benefits by infiltrating and detaining stormwater runoff.

Step-by-Step Guidance for Combination Flow and Volume Method

To apply the combination flow and volume approach, use the following steps, which may be performed using the combination flow and volume sizing criteria Excel worksheet provided in Attachment B-2 of this appendix.

1. Mean Annual Precipitation

- Determine the mean annual precipitation (MAP) for the project site using the Mean Annual Precipitation Map of Alameda County (Attachment B-3). Use the Oakland Airport unit basin storage volume values from Table B1-1 (below) if the

project location's mean annual precipitation is 16.4 inches or greater and the San Jose values if it is less than 16.4 inches.

- In order to account for the difference between MAP of the project site and the two rainfall locations shown, calculate the **MAP adjustment factor** by dividing the project MAP by the MAP for the applicable rain gauge, as shown below: MAP adjustment factor = (project location mean annual precipitation

$$\text{Map adjustment factor} = \frac{(\text{project location mean annual precipitation})}{(18.35 \text{ or } 14.4, \text{ as appropriate})}$$

2. Effective Impervious Area for the Drainage Management Area

- Based on the topography of the site and configuration of buildings, divide the site into drainage management areas (DMAs), each of which will drain to a treatment measure. Implement the steps below for each DMA with a volume-based treatment measure.
- Minimize the amount of landscaping or pervious pavement that will contribute runoff to the treatment measures. Refer to Sections 4.1 and 4.2 of the C.3 Stormwater Technical Guidance to design areas of landscaping or pervious pavement as “self-treating areas” or “self-retaining areas,” so that they do not contribute runoff to the LID treatment measure and may be excluded from the DMAs for the treatment measures.
- For each DMA in which the area that will contribute runoff to the treatment measure includes pervious surfaces (landscaping or properly designed pervious paving), multiply the area of pervious surface by a factor of 0.1.
- For applicable DMAs, add the product obtained in the previous step to the area of impervious surface, to obtain the “**effective impervious area.**” (For DMAs that are 100% impervious, use the entire DMA area.)

3. Unit Basin Storage Volume

- The effective impervious area of a DMA has a runoff coefficient of 1.0. Refer to Table B1-1 to obtain the **unit basin storage volume** that corresponds to your rain gauge area. For example, using the Oakland Airport gauge, the unit basin storage volume would be 0.67 inches. Adjust the unit basin storage volume for the site by multiplying the unit basin storage volume value by the MAP adjustment factor calculated in Step 1.
- Calculate the **required capture volume** by multiplying the effective impervious area of the DMA calculated in Step 2 by the adjusted unit basin storage volume. Due to the mixed units that result, such as acre-inches, it is recommended that the resulting volume be converted to cubic feet for use during design. For example, say you determined the adjusted unit basin storage volume to be 0.5 inches, and the effective impervious area draining to the bioretention facility is 7,000 square feet. Then the required capture volume would be:

$$\text{Required capture volume} = 0.5 \text{ inches} \times \left(\frac{1 \text{ foot}}{12 \text{ inches}} \right) \times 7,000 \text{ feet}^2 = 292 \text{ cubic feet}$$

Table B1-1. Unit Basin Storage Volume (Inches) for 80 Percent Capture with 48-Hour Drawdown Time

Location	Mean Annual Precipitation (inches)	Unit Basin Storage Volume for Effective Impervious Area of Drainage Management Area
		Coefficient of 1.00
Oakland Airport	18.35	0.67
San Jose	14.4	0.56

Source: CASQA 2003,¹ cited in Table 6-2 of the C.3 Technical Guidance.

4. Depth of Infiltration Trench or Pervious Paving Base Layer

- Assume that the rain event that generates the required capture volume of runoff determined in Step 3 occurs at a constant rainfall intensity of 0.2 inches/hour from the start of the storm (i.e., assume a rectangular hydrograph). Calculate the **duration of the rain event** by dividing the unit basin storage volume by the intensity. In other words, determine the amount of time required for the unit basin storage volume to be achieved at a rate of 0.2 inches/hour. For example, if the unit basin storage volume is 0.5 inches, the rain event duration is 0.5 inches ÷ 0.2 inches/hour = 2.5 hours.

5. Preliminary Estimate of the Surface Area the Facility

- Make a **preliminary estimate of the surface area** of the bioretention facility by multiplying the DMA's impervious area (or effective impervious surface if applicable) by the 4 percent method sizing factor of 0.04. For example, a drainage area that includes 7,000 square feet of impervious surface × 0.04 = 280 square feet of bioretention treatment area.
- Assume a bioretention area that is about 25% smaller than the bioretention area calculated with the 4 percent method. Using the example above, 280 – (0.25 × 280) = 210 square feet.
- Calculate the volume of runoff that filters through the biotreatment soil** at a rate of 5 inches per hour (the design surface loading rate for bioretention facilities), for the duration of the rain event calculated in Step 4. For example, for a bioretention treatment area of 210 square feet, with an infiltration rate of 5 inches per hour for a duration of 2.5 hours, the volume of treated runoff = 210 square feet × 5 inches/hour × (1 foot/12 inches) × 2.5 hours = 219 cubic feet. (Note: when calculating ponding depth, the mulch layer is not included in the calculation.)

6. Initial Adjustment of Depth of Surface Ponding Area

- Calculate the portion of the required capture volume **remaining after treatment is accomplished by filtering** through the treatment soil. The result is the amount that must be stored in the ponding area above the reduced bioretention area assumed in Step 6. For example, the amount remaining to be stored comparing

¹ California Stormwater Quality Association, 2003, Stormwater Best Management Practice Handbook: New Development and Redevelopment, www.casqa.org/sites/default/files/BMPHandbooks/BMP_NewDevRedev_Complete.pdf

Step 3 and Step 5 is 292 cubic feet – 219 cubic feet = 73 cubic feet. If this volume is stored over a surface area of 210 square feet, the **average ponding depth** would be 73 cubic feet ÷ 210 square feet = 0.35 feet or 4.2 inches.

- Check to see if the **average ponding depth is between 6 and 12 inches**, which is the recommended allowance for ponding in a bioretention facility or flow-through planter.

7. Optimize the Size of the Treatment Measure

- If the ponding depth is greater than 12 inches, a larger surface area will be required. (In the above example, the optimal size of the bioretention area is 190 square feet with a ponding depth of 6 inches.) In order to build conservatism into this sizing method, the Countywide Program recommends that municipalities not approve the design of any bioretention areas or rain gardens that have a surface area that is less than 3 percent of the effective impervious area within the DMA.

Please note that Appendix C of the C.3 Stormwater Technical Guidance includes an example of sizing bioretention areas using the combination flow- and volume-based method.

B1.2 Alternate Sizing Approach for Constrained Street Projects

Provision C.3.j.i.(2)(g) of the MRP allows the jurisdictions subject to the MRP (MRP Permittees) to develop an alternate sizing approach for street projects that are not subject to Provision C.3.b.ii. (non-Regulated Projects) in which project constraints preclude fully meeting the C.3.d sizing requirements. This approach, developed by the Bay Area Stormwater Management Agencies Association (BASMAA), is described as follows.

The Guidance for Sizing Green Infrastructure Facilities in Street Projects, provided by BASMAA and included as Attachment B-6, states that bioretention facilities in street projects should be sized as large as feasible and meet the Provision C.3.d sizing criteria where possible. It further states that bioretention facilities in street projects smaller than what would be required to meet the Provision C.3.d criteria may be appropriate in some circumstances, and provides guidance that may be applied to those circumstances.

Attachment B-2: Worksheet for Calculating the Combination Flow and Volume Method

The worksheet for calculating the combination flow and volume method is provided on the following page.

This page intentionally left blank

Worksheet for Calculating the Combination Flow and Volume Method

Instructions: After completing Section 1, make a copy of this Excel file for each Drainage Management Area within the project. Enter information specific to the project and DMA in the cells shaded in yellow. Cells shaded in light blue contain formulas and values that will be automatically calculated.

1.0 Project Information

- 1-1 Project Name:
- 1-2 City application ID:
- 1-3 Site Address or APN:
- 1-4 Tract or Parcel Map No:
- 1-5 Site Mean Annual Precip. (MAP)¹ **Inches**
- 1-6 Applicable Rain Gauge²

The calculations presented here are based on the **combination flow and volume hydraulic sizing method** provided in the Clean Water Program Alameda County C.3 Technical Guidance, Version 4.0. The steps presented below are explained in Chapter 5, Section 5.1 of the guidance manual, applicable portions of which are included in this file, in the tab called "Guidance from Chapter 5".

Refer to the Mean Annual Precipitation Map in Appendix D of the C.3 Technical Guidance to determine the MAP, in inches, for the site. [Click here for map](#)

Enter "Oakland Airport" if the site MAP is 16.4 inches or greater. Enter "San Jose" if the site MAP is less than 16.4 inches.

MAP adjustment factor is automatically calculated as:

(The "Site Mean Annual Precipitation (MAP)" is divided by the MAP for the applicable rain gauge, shown in Table 5.2, below.)

2.0 Calculate Percentage of Impervious Surface for Drainage Management Area (DMA)

- 2-1 Name of DMA:
- For items 2-2 and 2-3, enter the areas in square feet for each type of surface within the DMA.

Type of Surface	Area of surface type within DMA (Sq. Ft)	Adjust Pervious Surface	Effective Impervious Area
2-2 Impervious surface	<input type="text"/>	1.0	<input type="text"/>
2-3 Pervious service	<input type="text"/>	0.1	<input type="text"/>
Total DMA Area (square feet) =			<input type="text"/>

- 2-4 **Total Effective Impervious Area (EIA)** **Square feet**

3.0 Calculate Unit Basin Storage Volume in Inches

Applicable Rain Gauge	Mean Annual Precipitation (in)	Unit Basin Storage Volume (in) for Applicable Runoff Coefficients
		Coefficient of 1.00
Oakland Airport	18.35	0.67
San Jose	14.4	0.56

- 3-1 **Unit basin storage volume from Table 5.2:** **Inches**
(The coefficient for this method is 1.00, due to the conversion of any landscaping to effective impervious area)

- 3-2 **Adjusted unit basin storage volume:** **Inches**
(The unit basin storage volume is adjusted by applying the MAP adjustment factor.)

- 3-3 **Required Capture Volume (in cubic feet):** **Cubic feet**
(The adjusted unit basin sizing volume [inches] is multiplied by the size of the DMA and converted to feet)

4.0 Calculate the Duration of the Rain Event

- 4-1 Rainfall intensity **0.2 Inches per hour**
- 4-2 Divide Item 3-2 by Item 4-1 **Hours of Rain Event Duration**

5.0 Preliminary Estimate of Surface Area of Treatment Measure

- 5-1 4% of DMA impervious surface **Square feet**
- 5-2 Area 25% smaller than item 5-1 **Square feet**
- 5-3 Volume of treated runoff for area in Item 5-2 **Cubic feet** (Item 5-2 * 5 inches per hour * 1/12 * Item 4-2)

6.0 Initial Adjustment of Depth of Surface Ponding Area

- 6-1 Subtract Item 5-3 from Item 3-3 **Cubic feet** (Amount of runoff to be stored in ponding area)
- 6-2 Divide Item 6-1 by Item 5-2 **Feet** (Depth of stored runoff in surface ponding area)
- 6-3 Convert Item 6-2 from ft to inches **Inches** (Depth of stored runoff in surface ponding area)
- 6-4 If ponding depth in Item 6-3 meets your target depth, skip to Item 8-1. If not, continue to Step 7-1.

7.0 Optimize Size of Treatment Measure

- 7-1 Enter an area larger or smaller than Item 5-2 **Sq.ft.** (enter larger area if you need less ponding depth; smaller for more depth.)
- 7-2 Volume of treated runoff for area in Item 7-1 **Cubic feet** (Item 7-1 * 5 inches per hour * 1/12 * Item 4-2)
- 7-3 Subtract Item 7-2 from Item 3-3 **Cubic feet** (Amount of runoff to be stored in ponding area)
- 7-4 Divide Item 7-3 by Item 7-1 **Feet** (Depth of stored runoff in surface ponding area)
- 7-5 Convert Item 7-4 from feet to inches **Inches** (Depth of stored runoff in surface ponding area)
- 7-6 If the ponding depth in Item 7-5 meets target, stop here. If not, repeat Steps 7-1 through 7-5 until you obtain target depth

8.0 Surface Area of Treatment Measure for DMA

- 8-1 Final surface area of treatment* **Square feet** (Either Item 5-2 or final amount in Item 7-1)

*Note: Check with the local jurisdiction as to its policy regarding the minimum biotreatment surface area allowed.

This page intentionally left blank

Attachment B-3: Mean Annual Precipitation Map

The Mean Annual Precipitation Map for Alameda County is provided on the following page.

This page intentionally left blank

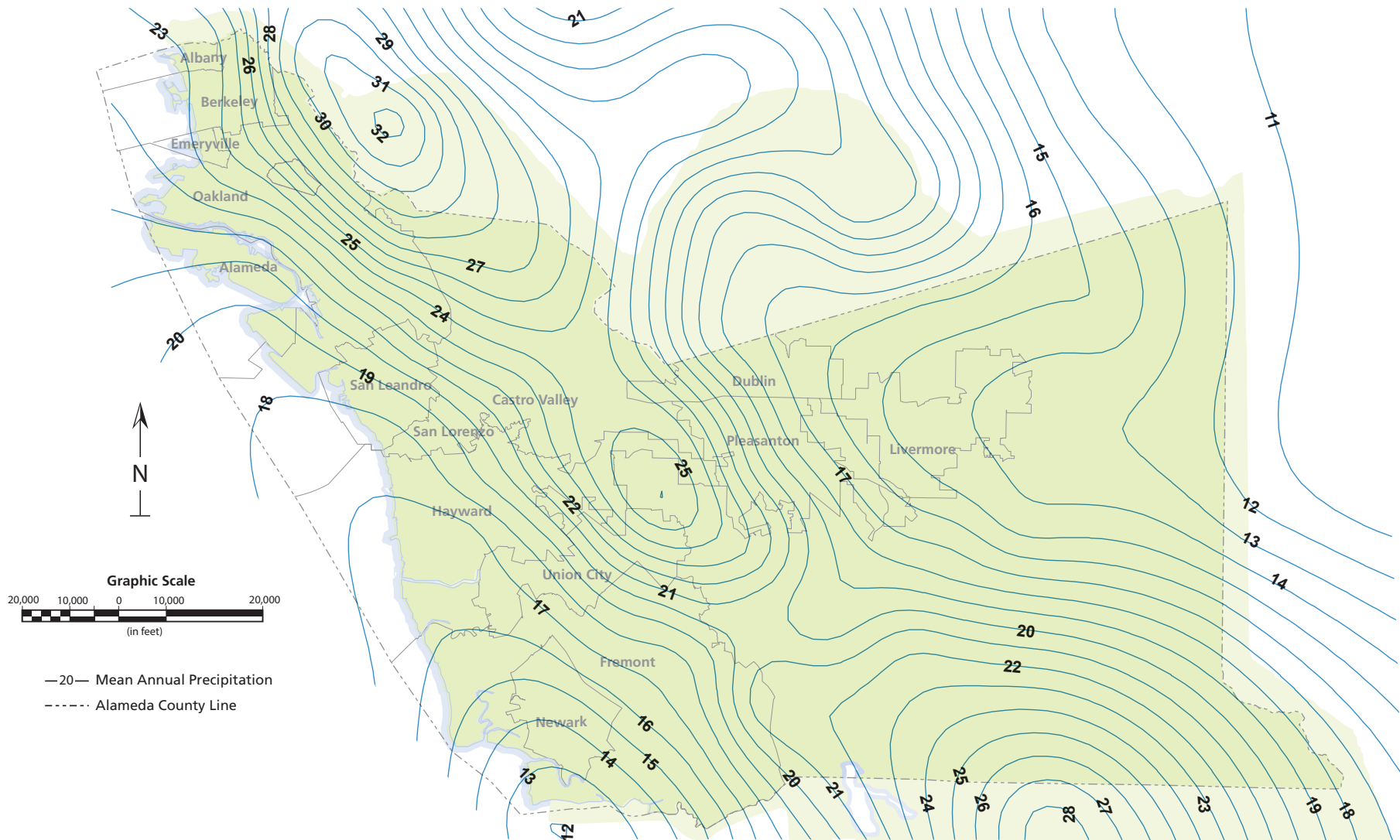

This map is Attachment 6 of the Alameda County Hydrology & Hydraulics Manual and may be downloaded as a GIS file from the Alameda County Flood Control District website.

(District 2011)



Mean Annual Precipitation

This page intentionally left blank

Attachment B-4: Standard Specifications and Typical Details

Standard specifications and typical details for green infrastructure (GI) projects are provided on the following pages, as indicated in Table B4-1.

Table B4-1: GI Example Typical Details/Standard Specifications

Sheet No.	Title of Drawing/Standard Specifications	Site Characteristics		
		Land Use	Street Classification	Other
GI-2A	Bioretention Area: Plan View with Street Parking	Commercial, industrial, or residential	Arterial, collector, or local streets	Parking lane
GI-2B	Bioretention Area: Bulbout Plan View	Commercial, industrial, or residential	Arterial, collector, or local streets	Intersection with sidewalks
GI-2C	Bioretention Area: Street Median	Commercial, industrial, or residential	Arterial, collector, or local streets	Median
GI-3A	Bioretention Area: Sloped Sides Cross Section	Commercial, industrial, or residential	Arterial, collector, or local streets	Sidewalk
GI-3B	Bioretention Area: Vertical Side Wall Cross Section	Commercial, industrial, or residential	Arterial, collector, or local streets	Parking lane and sidewalk
GI-4	Bioretention Components: Outlet Detail	Commercial, industrial, or residential	Arterial, collector, or local streets	--
GI-5	Bioretention Components: Edge Treatment Detail	Commercial, industrial, or residential	Arterial, collector, or local streets	No parking
GI-6A	Bioretention Components: Gutter Curb Cut Inlet Detail	Commercial, industrial, or residential	Arterial, collector, or local streets	--
GI-6B	Bioretention Components: Trench Drain Curb Cut Inlet Detail	Commercial, industrial, or residential	Arterial, collector, or local streets	Parking lane and sidewalk
GI-6C	Bioretention Components: Curb Cut At Bulbout Inlet Detail	Commercial, industrial, or residential	Arterial, collector, or local streets	Intersection with Sidewalks

Sheet No.	Title of Drawing/Standard Specifications	Site Characteristics		
		Land Use	Street Classification	Other
GI-7	Bioretention Components: Check Dam Detail	Commercial, industrial, or residential	Arterial, collector, or local streets	Slope requiring check dams
GI-8	Bioretention Area: With Bike Lane Plan View	Commercial, industrial, or residential	Arterial, collector, or local streets	Bike lane
--	Bioretention Soil Mix Specifications	All	All	--

Source: ACCWP, 2019²

² Alameda Countywide Clean Water Program, 2019, Example Typical Green Infrastructure Details.

PURPOSE:

PROVISION C.3 OF THE MUNICIPAL REGIONAL STORMWATER NPDES PERMIT (MRP) REQUIRES TREATMENT OF IMPERVIOUS SURFACES USING GREEN INFRASTRUCTURE FOR BOTH PUBLIC AND PRIVATE DEVELOPMENT PROJECTS. BIORETENTION AREAS ARE EXPECTED TO BE THE MOST COMMON GREEN INFRASTRUCTURE APPLICATION IN PUBLIC RIGHT-OF-WAY (ROW). THE PURPOSE OF THE BIORETENTION AREA IS TO IMPROVE WATER QUALITY BY FILTRATION THROUGH THE BIOTREATMENT SOIL AND TO CONTROL RUNOFF PEAK FLOW RATES AND VOLUMES THROUGH STORAGE AND INFILTRATION.

NOTES & GUIDELINES:

1. THE ENGINEER SHALL ADAPT PLAN AND SECTION DRAWINGS TO ADDRESS SITE-SPECIFIC CONDITIONS.
2. BIORETENTION AREA SHALL BE SIZED TO MEET THE REQUIREMENTS OF MRP PROVISION C.3 SIZING.
3. 48 HOUR MAXIMUM FACILITY DRAWDOWN TIME (TIME FOR MAXIMUM SURFACE PONDING TO DRAIN THROUGH THE BIOTREATMENT SOIL AFTER THE END OF A STORM). REFER TO C.3 TECHNICAL GUIDANCE MANUAL (ACCWP) FOR DRAINAGE CONSIDERATIONS.
4. A STORAGE LAYER OF CALTRANS STANDARD CLASS II PERMEABLE MATERIAL IS REQUIRED UNDER THE BIOTREATMENT SOIL. REFER TO C.3 TECHNICAL GUIDANCE MANUAL (ACCWP) FOR SPECIFICATIONS.
5. CHECK DAMS SHALL BE USED TO TERRACE FACILITIES TO PROVIDE SUFFICIENT PONDING FOR SLOPED INSTALLATIONS. ENGINEER SHALL SPECIFY CHECK DAM HEIGHT AND SPACING. REFER TO DETAIL **GI-7** FOR GUIDANCE ON CHECK DAM DESIGN.
6. DEPENDING ON THE DEPTH OF THE BIORETENTION AREA, ADDITIONAL STRUCTURAL CONSIDERATIONS MAY BE REQUIRED TO ADDRESS HORIZONTAL LOADING. REFER TO DETAIL **GI-5** FOR GUIDANCE ON EDGE TREATMENTS.
7. WHEN FACILITY CONSTRUCTION IMPACTS EXISTING SIDEWALK, ALL SAW CUTS SHALL ADHERE TO LOCAL JURISDICTION STANDARDS. SAW CUTS SHALL BE ALONG SCORE LINES OR ALONG CONSTRUCTION JOINTS, AS DETERMINED BY THE CITY ENGINEER, AND ANY DISTURBED SIDEWALK FLAGS SHALL BE REPLACED IN THEIR ENTIRETY.
8. BIORETENTION AREAS IN PUBLIC RIGHT OF WAY SHALL BE DESIGNED WITH AN EMERGENCY OVERFLOW. IN THE EVENT THE BIORETENTION AREA OVERFLOW DRAIN IS OBSTRUCTED OR CLOGGED, THE INUNDATION AREA SHALL BE CONTAINED WITHIN THE STREET AND SHALL NOT BE WITHIN ADJACENT PRIVATE PROPERTIES.
9. BIORETENTION AREA VEGETATION SHALL BE SPECIFIED BY LANDSCAPE DESIGN PROFESSIONAL. SEE C.3 TECHNICAL GUIDANCE MANUAL (ACCWP) FOR PLANT LIST AND VEGETATION GUIDANCE.
10. THE ENGINEER SHALL EVALUATE THE NEED FOR EROSION PROTECTION AT ALL INLET LOCATIONS. ALL COBBLES USED FOR ENERGY DISSIPATION SHALL BE GROUTED. ENGINEER TO CONSIDER MAINTENANCE REQUIREMENTS TO FACILITATE EASY SEDIMENT REMOVAL AND ADEQUATE VECTOR CONTROL.
11. THE PROJECT PLANS SHALL SHOW ALL EXISTING UTILITIES AND INDICATE POTENTIAL UTILITY CROSSINGS OR CONFLICTS.
12. CHECK WITH LOCAL JURISDICTION FOR UTILITY CROSSING PROVISIONS.
13. MINIMUM UTILITY SETBACKS AND PROTECTION MEASURES SHALL CONFORM TO CURRENT LOCAL JURISDICTION STANDARDS AND OTHER UTILITY PROVIDER REQUIREMENTS.
14. VERTICAL SIDEWALLS EXTENDING INTO EXISTING STORM DRAIN PIPE TRENCH BACKFILL SHALL BE DESIGNED WITH A CONCRETE BACKFILL ACCEPTABLE TO THE CITY ENGINEER.
15. OVERFLOW RISER MUST BE FORMED SUCH THAT IT IS A MINIMUM OF 6" ABOVE THE BOTTOM OF THE SYSTEM INLET, OR AS DESIGNED. PLACE STRUCTURE ADJACENT TO PEDESTRIAN EDGE TO ALLOW FOR MONITORING ACCESS.
16. DETAILS WERE ADAPTED FROM SFPUC GREEN INFRASTRUCTURE TYPICAL DETAILS AND SPECIFICATIONS.
17. DETAILS WERE DEVELOPED BY GEOSYNTEC CONSULTANTS.

ENGINEER CHECKLIST (SHALL SPECIFY, AS APPLICABLE):

- BIORETENTION AREA WIDTH AND LENGTH
- DEPTH OF PONDING
- AMOUNT OF FREEBOARD PROVIDED
- DEPTH OF BIOTREATMENT SOIL (18" MIN)
- UNDERDRAIN SPECIFICATIONS AND LOCATION (IF FACILITY IS LINED PLACE UNDERDRAIN AT BOTTOM OF FACILITY)
- BIORETENTION SURFACE ELEVATION (TOP OF BIOTREATMENT SOIL) AT UPSLOPE AND DOWNSLOPE ENDS OF FACILITY
- CONTROL POINTS AT EVERY BIORETENTION WALL CORNER AND POINT OF TANGENCY
- DIMENSIONS AND DISTANCE TO EVERY INLET, OUTLET, CHECK DAM, SIDEWALK NOTCH, ETC.
- ELEVATIONS OF EVERY INLET, OVERFLOW RISER, STRUCTURE RIM AND INVERT CHECK DAM, BIORETENTION AREA WALL CORNER, AND SIDEWALK NOTCH
- TYPE AND DESIGN OF BIORETENTION AREA COMPONENTS (E.G., EDGE TREATMENTS, INLETS/GUTTER MODIFICATIONS, UTILITY CROSSINGS, LINER, AND PLANTING DETAILS)
- DEPTH AND TYPE OF MULCH (NON-FLOATING; ORGANICALLY-DERIVED; NOT BARK OR GORILLA HAIR; 3" MIN)

RELATED TECHNICAL GUIDANCE	SOURCE
BIORETENTION: - BIOTREATMENT SOIL MIX - CALTRANS CLASS II PERM LAYER STORAGE - PERFORATED UNDERDRAIN - NON-FLOATING MULCH	C.3 TECHNICAL GUIDANCE MANUAL (ACCWP)

NOT FOR CONSTRUCTION

BIORETENTION AREA: NOTES



**GREEN INFRASTRUCTURE
EXAMPLE DETAILS**
ALAMEDA COUNTYWIDE CLEAN
WATER PROGRAM

SCALE: NOT TO SCALE
 DATE: MAY 11, 2018 REVISED: JUNE 11, 2019
 DRAWN BY: K. K. REVISED BY: E. F.
 CHECKED BY: A. R.

GI-1

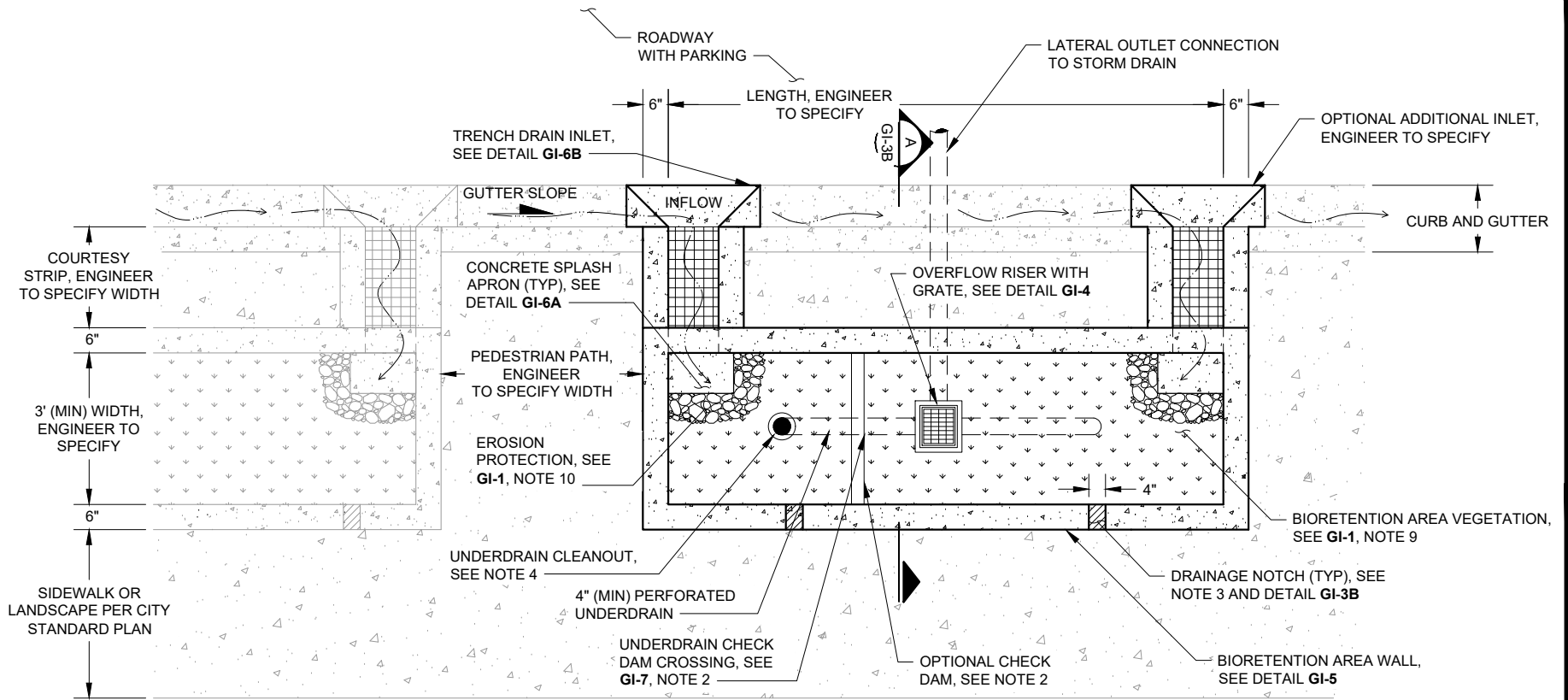

NOTES:

1. REFER TO GI-1 NOTES FOR GUIDELINES AND CHECKLIST.
2. CHECK DAMS SHALL BE SPACED TO PROVIDE PONDING PER SITE SPECIFIC DESIGN (SEE DETAIL GI-7).
3. LAY OUT DRAINAGE NOTCHES AS APPLICABLE TO PREVENT PONDING BEHIND BIORETENTION AREA WALL WITH 5' MAXIMUM SPACING BETWEEN NOTCHES.
4. PROVIDE ONE UNDERDRAIN CLEANOUT PER BIORETENTION AREA (MIN). CLEANOUT REQUIRED AT UPSTREAM END AND PIPE ANGLE POINTS EXCEEDING 45 DEGREES. LONGITUDINAL SLOPE OF PIPE SHALL BE 0.5% (MIN).

NOT FOR CONSTRUCTION

BIORETENTION AREA: PLAN VIEW WITH STREET PARKING



GREEN INFRASTRUCTURE
EXAMPLE DETAILS
ALAMEDA COUNTYWIDE CLEAN
WATER PROGRAM

SCALE: NOT TO SCALE
DATE: MAY 11, 2018 REVISED: JUNE 11, 2019
DRAWN BY: K. K REVISED BY: E. F.
CHECKED BY: A. R.

GI-2A

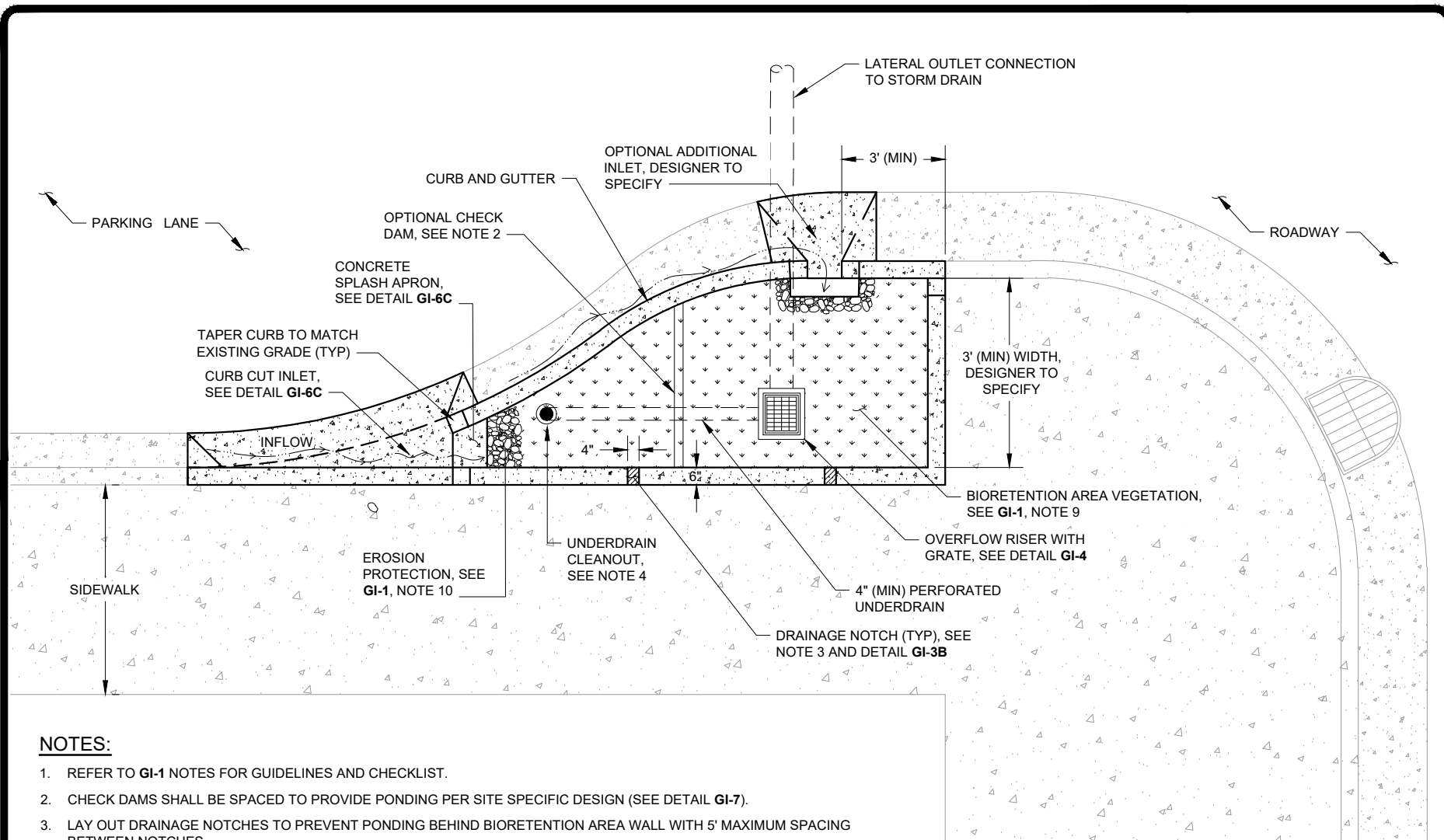

NOTES:

1. REFER TO GI-1 NOTES FOR GUIDELINES AND CHECKLIST.
2. CHECK DAMS SHALL BE SPACED TO PROVIDE PONDING PER SITE SPECIFIC DESIGN (SEE DETAIL GI-7).
3. LAY OUT DRAINAGE NOTCHES TO PREVENT PONDING BEHIND BIORETENTION AREA WALL WITH 5' MAXIMUM SPACING BETWEEN NOTCHES.
4. PROVIDE ONE UNDERDRAIN CLEANOUT PER BIORETENTION AREA (MIN). CLEANOUT REQUIRED AT UPSTREAM END AND PIPE ANGLE POINTS EXCEEDING 45 DEGREES. LONGITUDINAL SLOPE OF PIPE SHALL BE 0.5% (MIN).

NOT FOR CONSTRUCTION

BIORETENTION AREA: BULBOUT PLAN VIEW



GREEN INFRASTRUCTURE
EXAMPLE DETAILS
ALAMEDA COUNTYWIDE CLEAN
WATER PROGRAM

SCALE: NOT TO SCALE	
DATE: MAY 11, 2018	REVISED: JUNE 11, 2019
DRAWN BY: K. K.	REVISED BY: E. F.
CHECKED BY: A. R.	

GI-2B

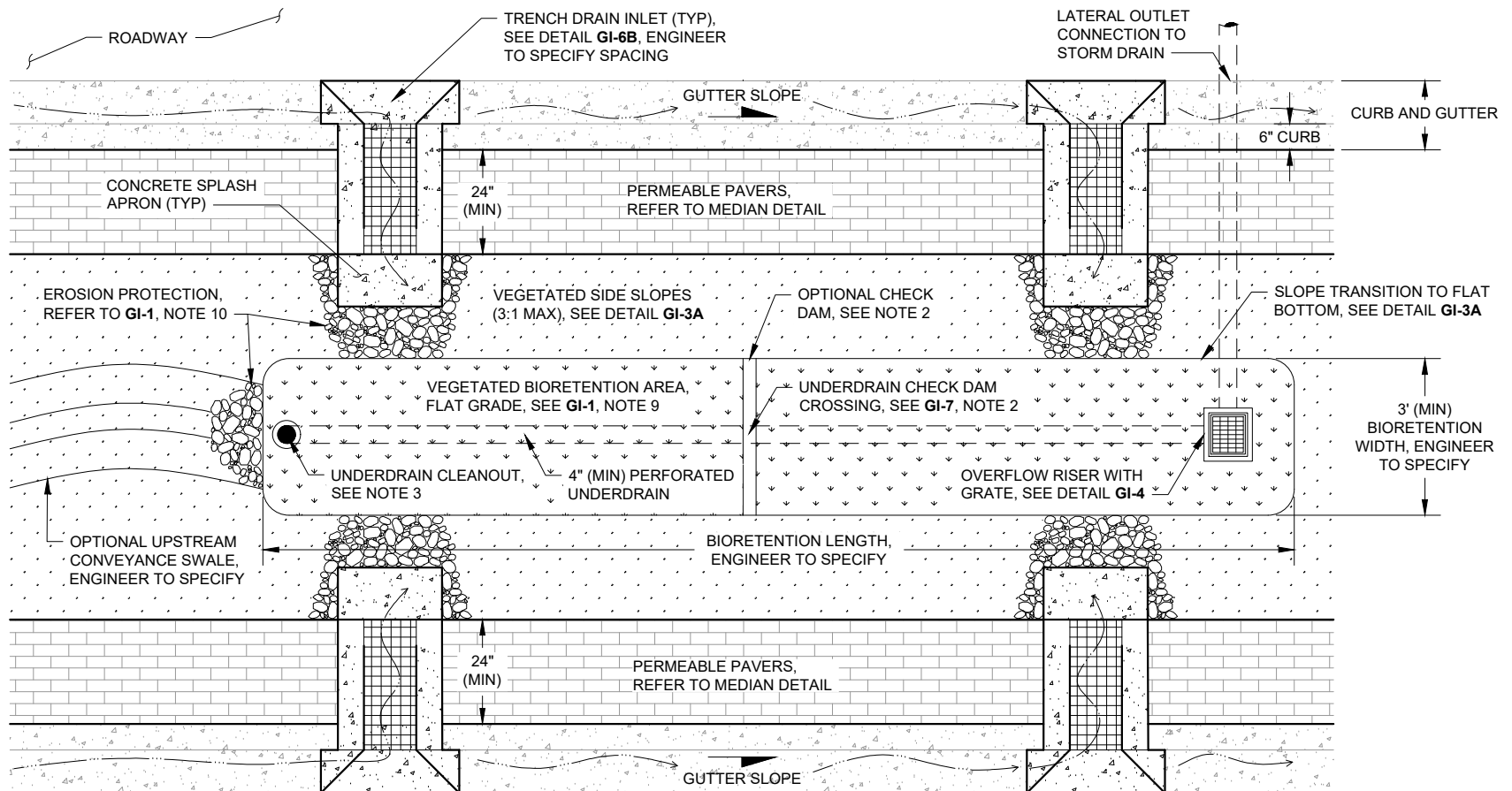

NOTES:

1. REFER TO **GI-1** NOTES FOR GUIDELINES AND CHECKLIST.
2. CHECK DAMS SHALL BE SPACED TO PROVIDE PONDING PER SITE SPECIFIC DESIGN (SEE DETAIL **GI-7**).
3. PROVIDE ONE UNDERDRAIN CLEANOUT PER BIORETENTION AREA (MIN). CLEANOUT REQUIRED AT UPSTREAM END AND PIPE ANGLE POINTS EXCEEDING 45 DEGREES. LONGITUDINAL SLOPE OF PIPE SHALL BE 0.5% (MIN).
4. DESIGNERS TO REFERENCE AASHTO ROADSIDE SAFETY DESIGN REQUIREMENTS AND CONSIDER USE OF MEDIAN BIORETENTION AREAS IN RELATION TO STREET CLASSIFICATION AND STREET SPEEDS.
5. A STORAGE VOLUME SAFETY FACTOR OF 1.5 SHALL BE INCLUDED IN THE DESIGN OF MEDIAN BIORETENTION AREAS TO PREVENT FLOODING.
6. SLOPED SIDES (**GI-3A**) DEPICTED IN PLAN VIEW ABOVE, REFER TO **GI-3B** IF VERTICAL SIDE WALLS ARE USED.

NOT FOR CONSTRUCTION



**GREEN INFRASTRUCTURE
EXAMPLE DETAILS**
ALAMEDA COUNTYWIDE CLEAN
WATER PROGRAM

BIORETENTION AREA: STREET MEDIAN

SCALE: NOT TO SCALE
DATE: MAY 11, 2018 REVISED: JUNE 11, 2019
DRAWN BY: K. K. REVISED BY: E. F.
CHECKED BY: A. R.

GI-2C

NOTES:

1. REFER TO **GI-1** NOTES FOR GUIDELINES AND CHECKLIST.
2. AVOID UNNECESSARY COMPACTION OF EXISTING SUBGRADE BELOW AREA.
3. SCARIFY SUBGRADE TO A DEPTH OF 3" (MIN) IMMEDIATELY PRIOR TO PLACEMENT OF CALTRANS CLASS 2 PERMEABLE MATERIAL STORAGE LAYER AND BIOTREATMENT SOIL MATERIALS.
4. AGGREGATE STORAGE LAYER COMPRISED OF 12" MIN CALTRANS CLASS 2 PERMEABLE MATERIAL.
5. REFER TO C.3 TECHNICAL GUIDANCE MANUAL (ACCWP) FOR BIOTREATMENT SOIL MIX SPECIFICATIONS. INSTALL BIOTREATMENT SOIL AT 85% COMPACTION FOLLOWING BASMAA INSTALLATION GUIDANCE.
6. ANGLE OF REPOSE VARIES PER GEOTECHNICAL ENGINEER RECOMMENDATIONS.
7. UNDERDRAIN AND CLEAN OUT PIPE (1 MIN PER FACILITY) REQUIRED, REFER TO C.3 TECHNICAL GUIDANCE MANUAL (ACCWP) FOR DESIGN CONSIDERATIONS. UNDERDRAINS SHOULD BE ELEVATED 6" (MIN) WITHIN THE CALTRANS CLASS 2 PERMEABLE MATERIAL STORAGE LAYER TO PROMOTE INFILTRATION. IN FACILITIES WITH AN IMPERMEABLE LINER, THE UNDERDRAIN SHOULD BE PLACED AT THE BOTTOM OF THE CALTRANS CLASS 2 PERMEABLE MATERIAL STORAGE LAYER. PERFORATED/SLOT DRAINS SHOULD BE DOWNWARD FACING TO FACILITATE BETTER STORAGE IN THE GRAVEL LAYER.
8. THE UNDERDRAIN IN ALL FACILITIES LOCATED IN THE PUBLIC RIGHT-OF-WAY SHALL BE VIDEO RECORDED AND PROVIDED TO THE CITY FOR REVIEW PRIOR TO PROJECT ACCEPTANCE.
9. REFER TO LOCAL JURISDICTION STANDARDS FOR CURB AND SIDEWALK DETAILS.

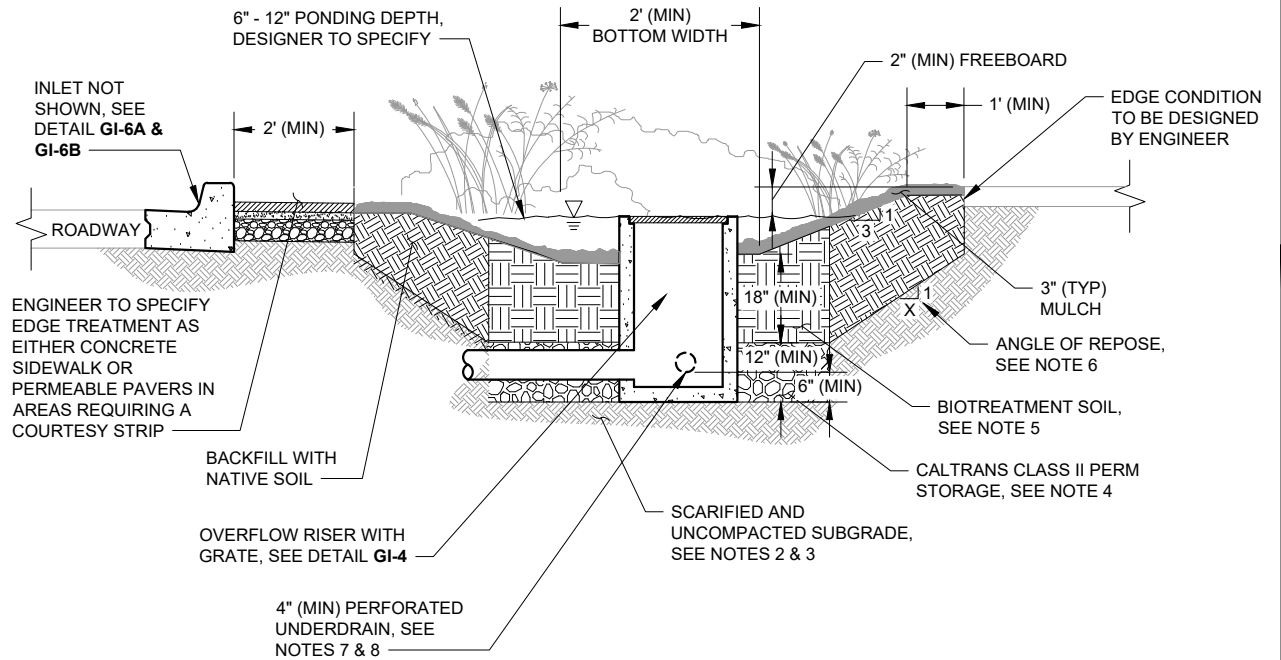

NOT FOR CONSTRUCTION

BIORETENTION AREA: SLOPED SIDES CROSS SECTION



GREEN INFRASTRUCTURE
EXAMPLE DETAILS
ALAMEDA COUNTYWIDE CLEAN
WATER PROGRAM

SCALE: NOT TO SCALE
DATE: MAY 11, 2018 REVISED: JUNE 11, 2019
DRAWN BY: K. K. REVISED BY: E. F.
CHECKED BY: A. R.

GI-3A

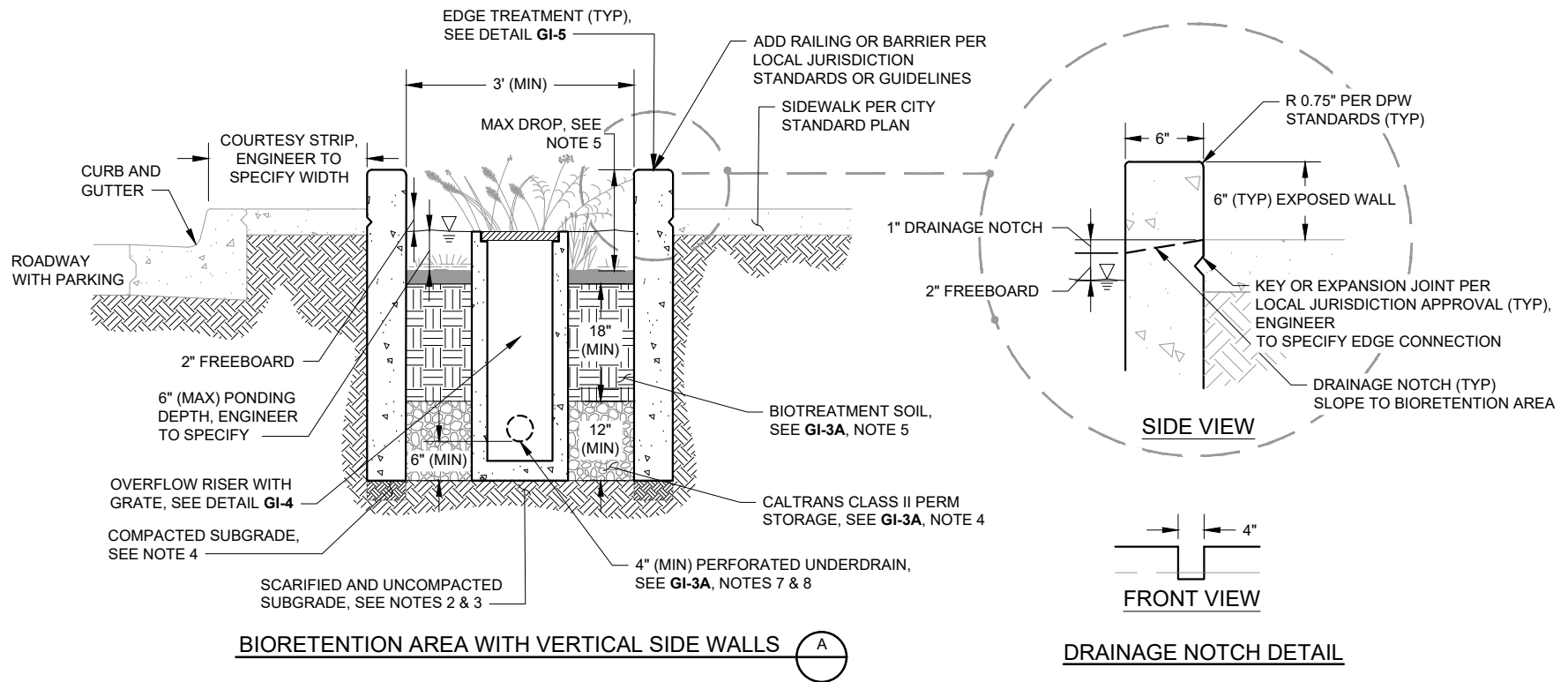

NOTES:

1. REFER TO GI-1 NOTES FOR GUIDELINES AND CHECKLIST.
2. AVOID UNNECESSARY COMPACTION OF EXISTING SUBGRADE BELOW BIORETENTION AREA.
3. SCARIFY SUBGRADE TO A DEPTH OF 3" (MIN) IMMEDIATELY PRIOR TO PLACEMENT OF AGGREGATE STORAGE AND BIOTREATMENT SOIL MATERIAL.
4. FOR STRUCTURAL SUPPORT, SUBGRADE UNDER WALLS ONLY COMPACTED PER ENGINEER SPECIFICATIONS.
5. MAXIMUM DROP, PER LOCAL BUILDING CODE, FROM TOP OF CURB TO TOP OF BIOTREATMENT SOIL SHALL INCLUDE CONSIDERATIONS FOR BIOTREATMENT SOIL SETTLEMENT. THE DROP IS THE SUM OF PONDING DEPTH (6" TYP), FREEBOARD (2" TYP), AND CURB HEIGHT (6" TYP).
6. REFER TO LOCAL JURISDICTION STANDARDS FOR CURB AND SIDEWALK DETAILS.

NOT FOR CONSTRUCTION



**GREEN INFRASTRUCTURE
EXAMPLE DETAILS**
ALAMEDA COUNTYWIDE CLEAN
WATER PROGRAM

SCALE: NOT TO SCALE
DATE: MAY 11, 2018 REVISED: JUNE 11, 2019
DRAWN BY: K. K. REVISED BY: E. F.
CHECKED BY: A. R.

GI-3B

NOTES:

1. REFER TO **GI-1** NOTES FOR GUIDELINES AND CHECKLIST.
2. ALL MATERIAL AND WORKMANSHIP FOR OVERFLOW STRUCTURES SHALL CONFORM TO LOCAL JURISDICTION STANDARDS.
3. DESIGN OVERFLOW WEIR AND OUTLET PIPE TO CONVEY 10-YR, 24-HR STORM FLOW OR DESIGN INLET TO DIVERT FLOWS LARGER THAN THE DESIGN STORM DIRECTLY TO THE STORM DRAIN. LOCATE ALL OVERFLOW PIPES AT AN ELEVATION HIGHER THAN THE STORM SEWER HYDRAULIC GRADE LINE TO PREVENT BACKFLOW INTO THE BIORETENTION FACILITY.
4. STORM DRAIN OUTLET PIPES SHALL BE SIZED TO MEET HYDRAULIC REQUIREMENTS WITH APPROPRIATE COVER DEPTH AND PIPE MATERIAL.
5. PERFORATED UNDERDRAINS WITH CLEANOUT PIPES ARE REQUIRED. PERFORATED/SLOT DRAINS SHOULD BE DOWNWARD FACING TO FACILITATE BETTER STORAGE IN THE GRAVEL LAYER.
6. MAINTENANCE ACCESS IS REQUIRED FOR ALL OUTLET STRUCTURES AND CLEANOUT FACILITIES. 12" (MIN) CLEARANCE WITHIN OVERFLOW STRUCTURE SHALL BE PROVIDED FOR MAINTENANCE ACCESS.
7. ENGINEER SHALL REFER TO LOCAL JURISDICTION STANDARDS AND/OR ASSESS NEED FOR GRAVEL BASE. ENGINEER SHALL EVALUATE BUOYANCY OF STRUCTURES FOR SITE SPECIFIC APPLICATION AND SPECIFY THICKENED OR EXTENDED BASE / ANTI-FLOATATION COLLAR, AS NECESSARY.
8. SIZE OF GRATE SHALL MATCH SIZE OF RISER SPECIFIED IN PLANS, SHALL BE REMOVABLE TO PROVIDE MAINTENANCE ACCESS, AND SHALL BE BOLTED IN PLACE OR OUTFITTED WITH APPROVED TAMPER-RESISTANT LOCKING MECHANISM. MAXIMUM GRATE OPENING SHALL BE 2".
9. IF INTERIOR DEPTH OF OVERFLOW STRUCTURE EXCEEDS 5', A PERMANENT BOLTED LADDER AND MINIMUM CLEAR SPACE OF 30" BY 30" SHALL BE PROVIDED FOR MAINTENANCE ACCESS.
10. MINIMUM DIAMETER OF OPTIONAL GROUTED COBBLES SHALL BE LARGER THAN MAXIMUM GRATE OPENING.
11. GROUT ALL PENETRATIONS, CRACKS, SEAMS, AND JOINTS WITH CLASS "C" MORTAR.

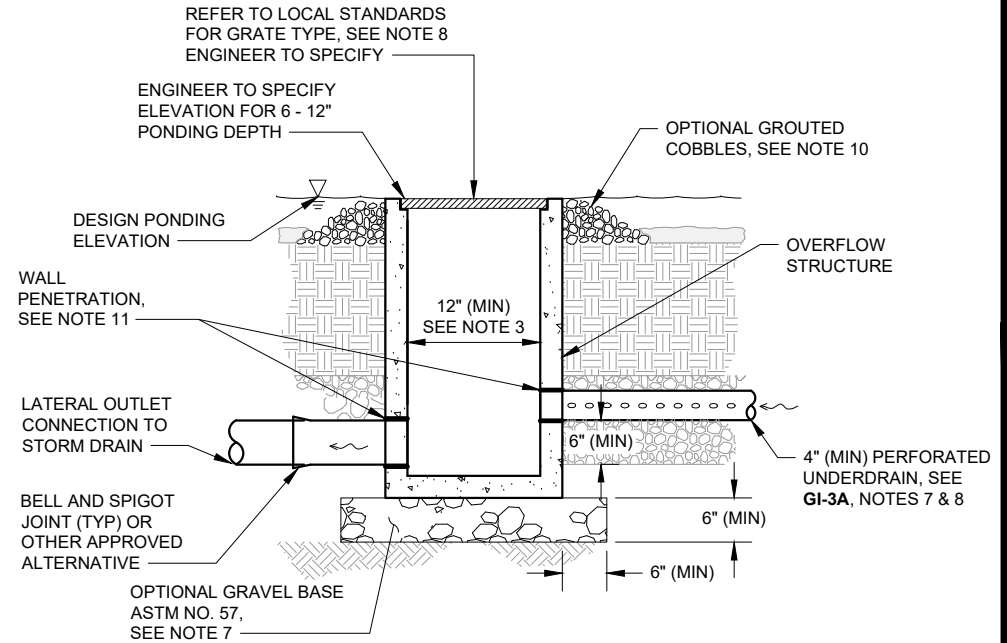

NOT FOR CONSTRUCTION

BIORETENTION COMPONENTS: OUTLET DETAIL



**GREEN INFRASTRUCTURE
EXAMPLE DETAILS**
ALAMEDA COUNTYWIDE CLEAN
WATER PROGRAM

SCALE: NOT TO SCALE
DATE: MAY 11, 2018 REVISED: JUNE 11, 2019
DRAWN BY: K. K. REVISED BY: E. F.
CHECKED BY: A. R.

GI-4

NOTES:

1. REFER TO GI-1 NOTES FOR GUIDELINES AND CHECKLIST.
2. THE ENGINEER SHALL ADAPT EDGE TREATMENT DESIGN TO ADDRESS SITE SPECIFIC CONSTRAINTS TO EFFECTIVELY STABILIZE ADJACENT PAVEMENT AND MINIMIZE LATERAL MOVEMENT OF WATER.
3. STANDARD CURB EDGE (WHEN SPACE AVAILABLE):
 - A. REFER TO LOCAL JURISDICTION STANDARDS FOR CURB AND SIDEWALK DETAILS.
 - B. ANGLE OF REPOSE VARIES PER GEOTECHNICAL ENGINEERS RECOMMENDATIONS.
4. VERTICAL SIDE WALLS (WHEN SPACE LIMITED):
 - A. ALL BIORETENTION AREA WALLS SHALL EXTEND TO BOTTOM OF AGGREGATE STORAGE LAYER OR DEEPER. MINIMUM DEPTHS SHALL BE DESIGNED TO PREVENT LATERAL SEEPAGE INTO THE ADJACENT PAVEMENT SECTION.
 - B. FOOTING AND/OR LATERAL BRACING SHALL BE DESIGNED BY THE ENGINEER TO WITHSTAND ANTICIPATED LOADING ASSUMING NO REACTIVE FORCES FROM THE UNCOMPACTED BIOTREATMENT SOIL.
 - C. BIORETENTION AREA WALLS EXTENDING MORE THAN 36" BELOW ADJACENT LOAD-BEARING SURFACE, OR WHEN LOCATED ADJACENT TO PAVERS, SHALL HAVE FOOTING OR LATERAL BRACING. FOOTING OR LATERAL BRACING MAY BE EXCLUDED ONLY IF THE ENGINEER DEMONSTRATES THAT THE PROPOSED WALL DESIGN MEETS LOADING REQUIREMENTS. WALL SHALL NOT ENCRANCH INTO TREATMENT AREA.
 - D. CONTRACTOR TO PROVIDE 3" MINIMUM COVER OVER ALL LATERAL BRACING FOR PLANT ESTABLISHMENT.
 - E. ALL CONSTRUCTION COLD JOINTS SHALL INCORPORATE EPOXY, DOWEL/TIE BAR, KEYWAY, OR WATER STOP.

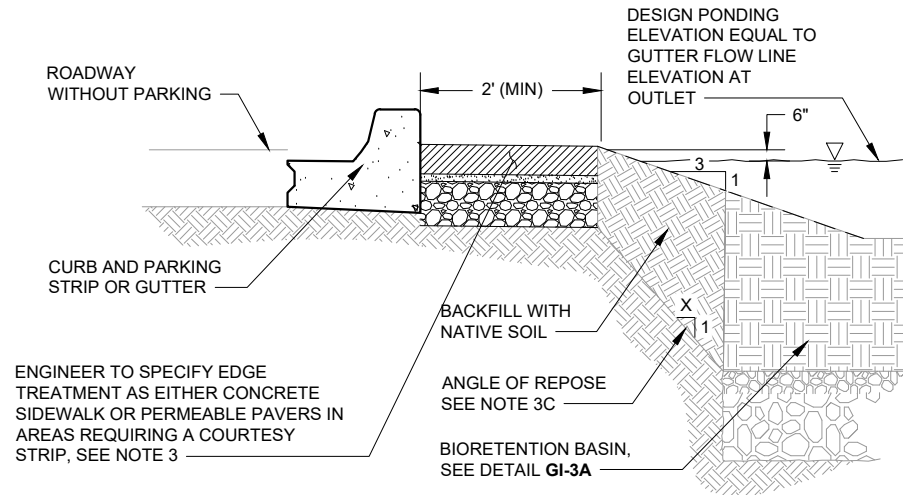

STANDARD CURB EDGE AT BIORETENTION BASIN

1

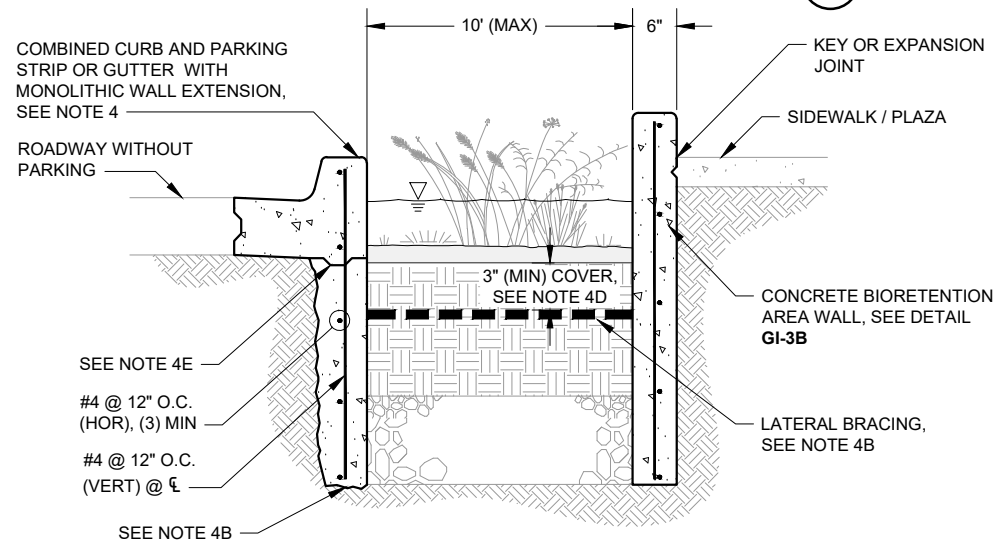

EXTENDED BIORETENTION AREA WALL WITH LATERAL BRACING

2

NOT FOR CONSTRUCTION

BIORETENTION COMPONENTS: EDGE TREATMENT DETAIL



GREEN INFRASTRUCTURE
EXAMPLE DETAILS
ALAMEDA COUNTYWIDE CLEAN
WATER PROGRAM

SCALE: NOT TO SCALE	
DATE: MAY 11, 2018	REVISED: JUNE 11, 2019
DRAWN BY: K. K.	REVISED BY: E. F.
CHECKED BY: A. R.	

GI-5

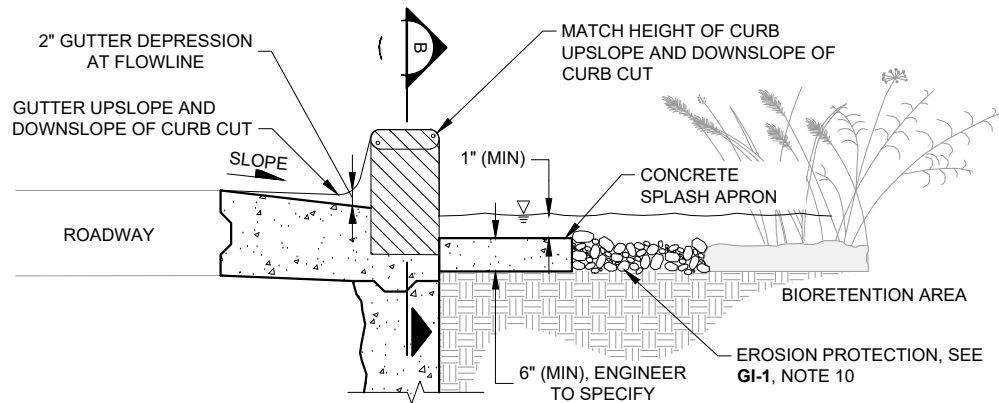
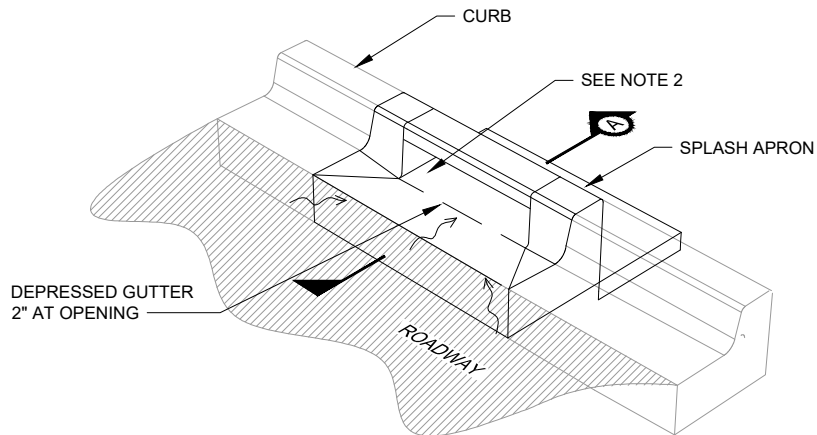

ISOMETRIC

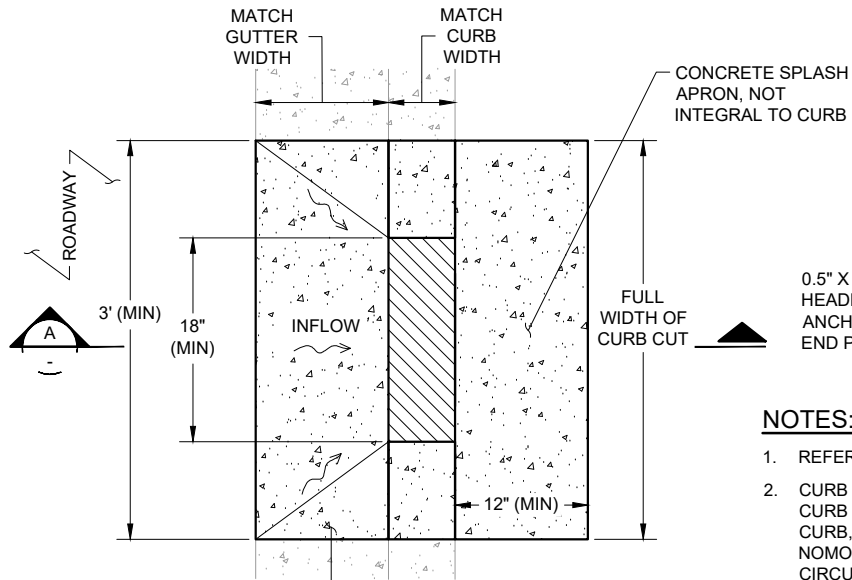

PLAN

METAL INLET ASSEMBLY

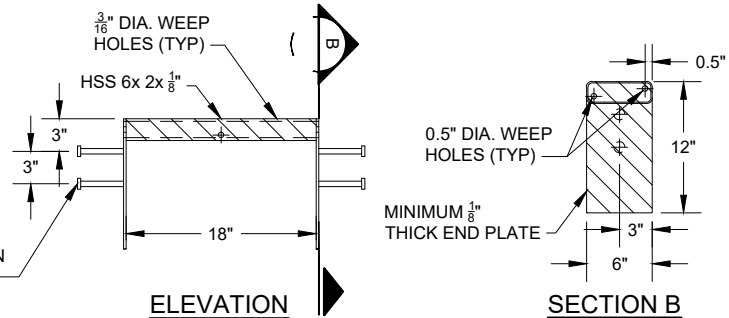

NOTES:

1. REFER TO GI-1 NOTES FOR GUIDELINES AND CHECKLIST.
2. CURB CUT INLETS SHALL BE ADEQUATELY SIZED, SPACED, AND SLOPED TO MEET HYDRAULIC REQUIREMENTS. THE CURB CUT OPENING WIDTH SHALL BE SIZED BASED ON THE CATCHMENT AREA, LONGITUDINAL SLOPE ALONG THE CURB, AND THE CROSS SLOPE OF THE GUTTER OR ADJACENT PAVEMENT AT THE INLET. SEE SIZING EQUATIONS AND NOMOGRAPHS FOR CURB OPENING INLETS IN THE U.S. DEPARTMENT OF TRANSPORTATION HYDRAULIC ENGINEERING CIRCULAR NO. 27.
3. BOND NEW CURB AND GUTTER TO EXISTING CURB AND GUTTER WITH EPOXY AND DOWEL CONNECTION.
4. METAL INLET ASSEMBLY SHALL BE HOT-DIP GALVANIZED IN ACCORDANCE WITH ASTM A-123.

NOT FOR CONSTRUCTION

BIORETENTION COMPONENTS: GUTTER CURB CUT INLET DETAIL



GREEN INFRASTRUCTURE
EXAMPLE DETAILS
ALAMEDA COUNTYWIDE CLEAN
WATER PROGRAM

SCALE: NOT TO SCALE	
DATE: MAY 11, 2018	REVISED: JUNE 11, 2019
DRAWN BY: K. K.	REVISED BY: E.F.
CHECKED BY: A. R.	

GI-6A

NOTES:

1. REFER TO GI-1 NOTES FOR GUIDELINES AND CHECKLIST.
2. ALL MATERIAL AND WORKMANSHIP FOR TRENCH DRAIN ASSEMBLY SHALL CONFORM TO LOCAL JURISDICTION STANDARDS.
3. TRENCH DRAIN INLETS SHALL BE ADEQUATELY SIZED, SPACED, AND SLOPED TO MEET HYDRAULIC REQUIREMENTS. SEE NOTE 2 DETAIL GI-6A FOR REFERENCE.
4. SLOPE TO PROVIDE AT LEAST 1" DROP OVER LENGTH OF CHANNEL OR A MINIMUM OF 2%, WHICHEVER IS LARGER.
5. ALL TRENCH GRATES SHALL BE REMOVABLE, RATED PER THE ANTICIPATED LOADING, AND BOLTED IN PLACE OR OUTFITTED WITH APPROVED TAMPER-RESISTANT LOCKING MECHANISM, FLUSH OR RECESSED IN GRATE.
6. BOND NEW CURB AND GUTTER TO EXISTING CURB AND GUTTER WITH EPOXY AND DOWEL CONNECTION.
7. HORIZONTAL CONTROL JOINTS SHALL BE PROVIDED EVERY 10' (LINEAR), OR PER MANUFACTURER'S RECOMMENDATIONS.
8. APPLY EPOXY BONDING AGENT AT ALL TRENCH DRAIN CONSTRUCTION COLD JOINTS.
9. INLET CURB CUT AND CONCRETE CHANNEL WIDTH SHALL BE SIZED TO ACCOUNT FOR CATCHMENT AREA AND GUTTER SLOPE.

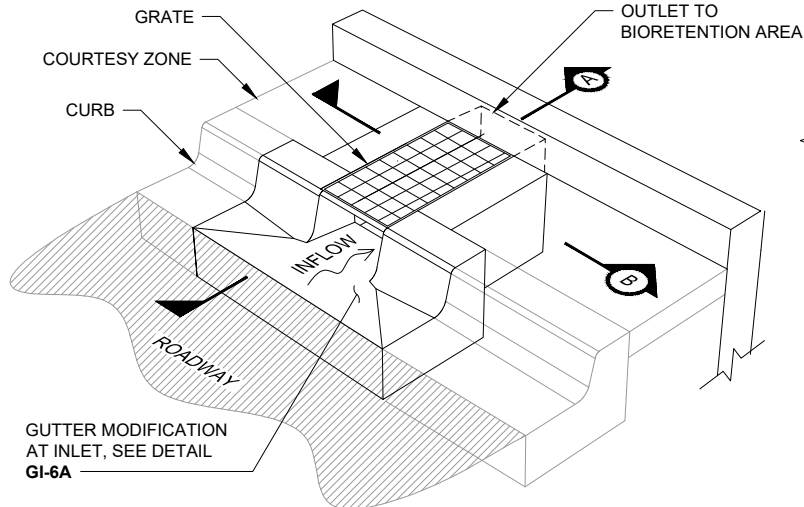

ISOMETRIC

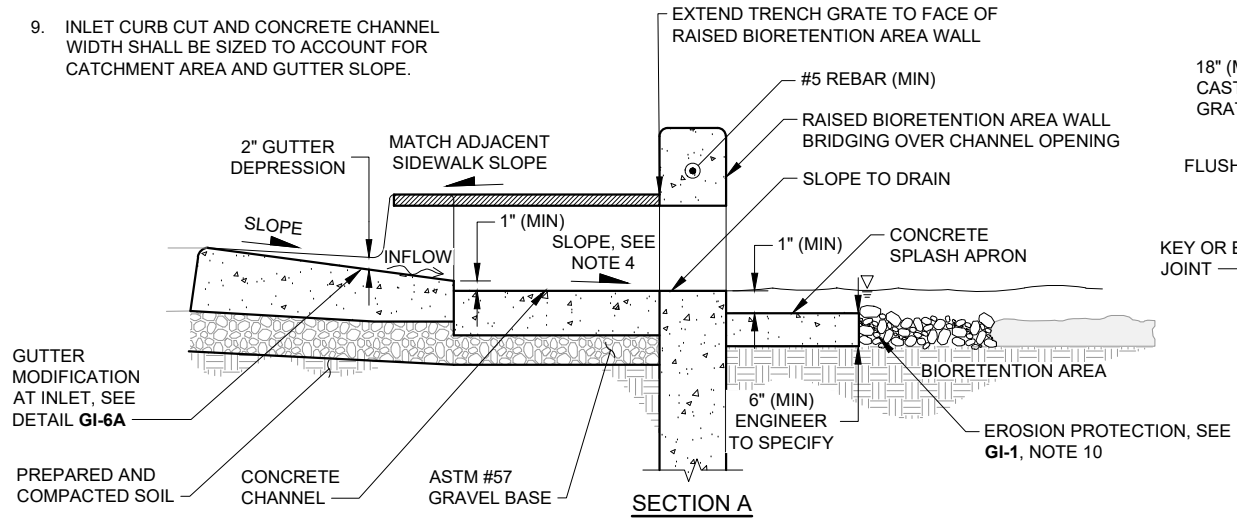
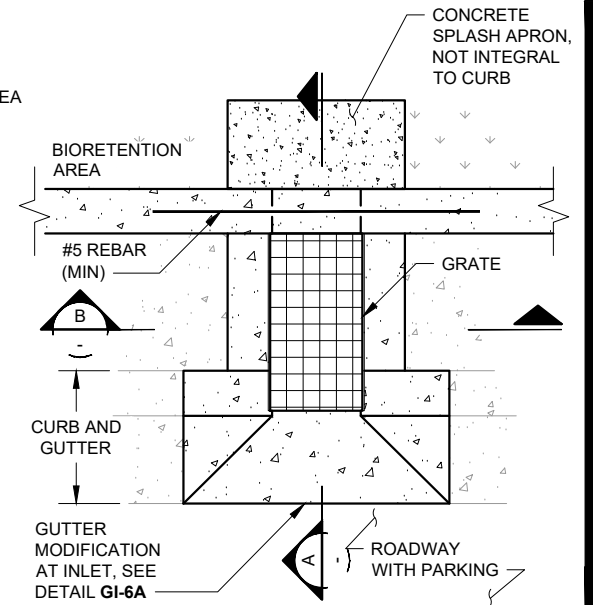

SECTION A

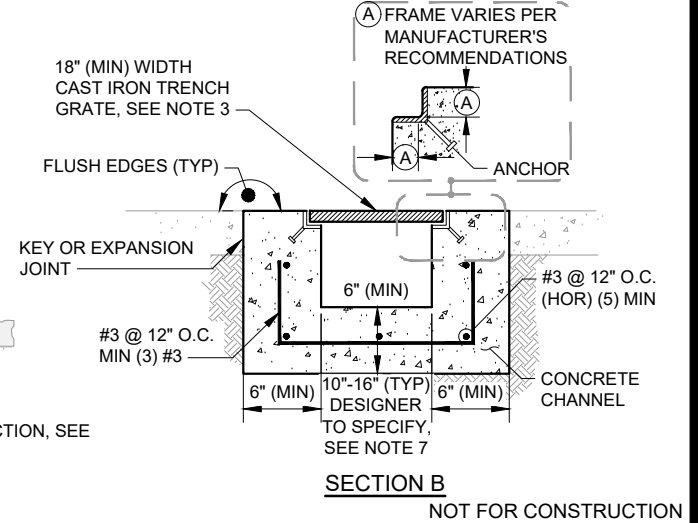

SECTION B

NOT FOR CONSTRUCTION

BIORETENTION COMPONENTS: TRENCH DRAIN CURB CUT INLET DETAIL



**GREEN INFRASTRUCTURE
EXAMPLE DETAILS**
ALAMEDA COUNTYWIDE CLEAN
WATER PROGRAM

SCALE: NOT TO SCALE
DATE: MAY 11, 2018 REVISED: JUNE 11, 2019
DRAWN BY: K. K. REVISED BY: E. F.
CHECKED BY: A. R.

GI-6B

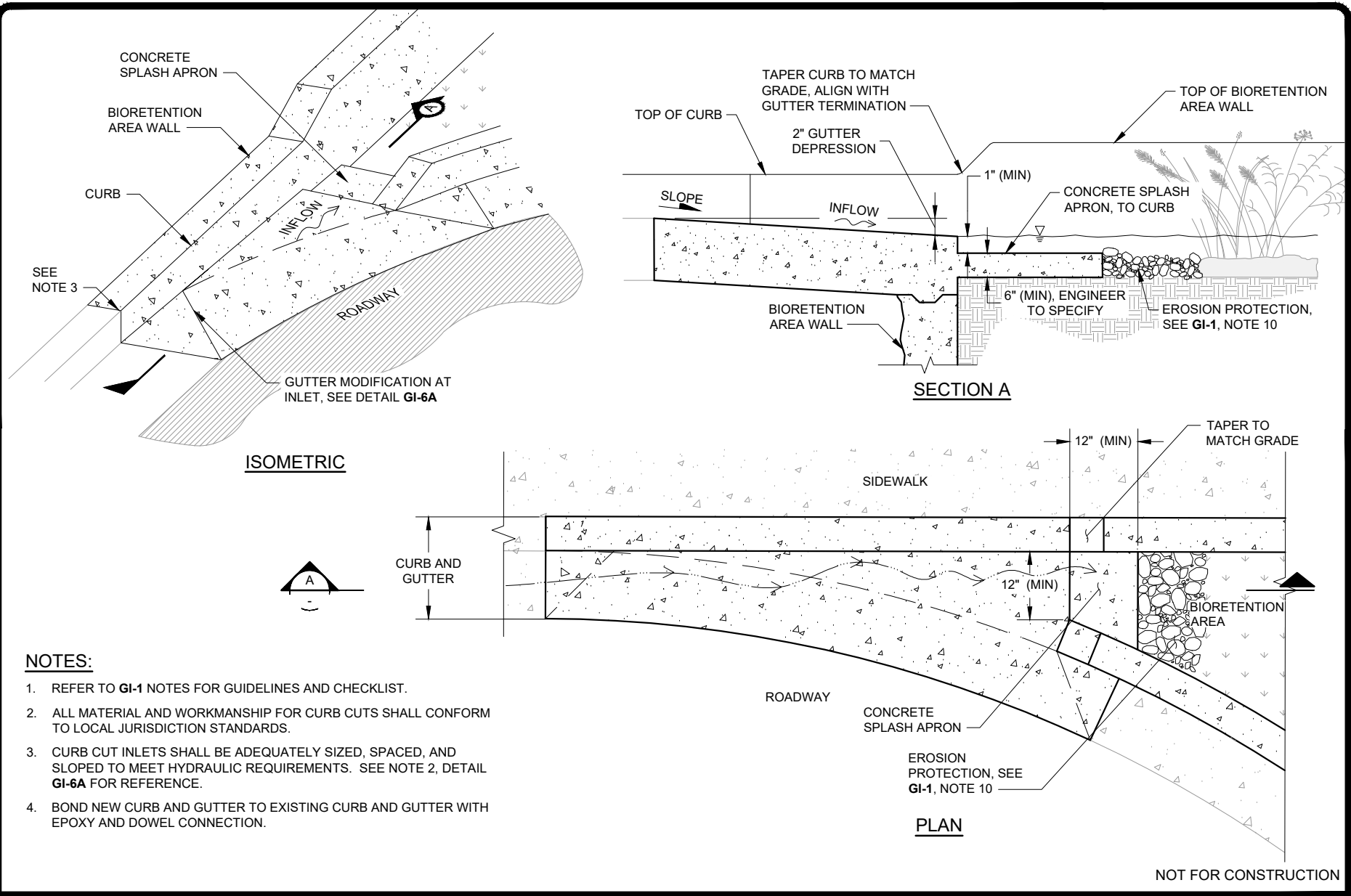

NOTES:

1. REFER TO GI-1 NOTES FOR GUIDELINES AND CHECKLIST.
2. ALL MATERIAL AND WORKMANSHIP FOR CURB CUTS SHALL CONFORM TO LOCAL JURISDICTION STANDARDS.
3. CURB CUT INLETS SHALL BE ADEQUATELY SIZED, SPACED, AND SLOPED TO MEET HYDRAULIC REQUIREMENTS. SEE NOTE 2, DETAIL GI-6A FOR REFERENCE.
4. BOND NEW CURB AND GUTTER TO EXISTING CURB AND GUTTER WITH EPOXY AND DOWEL CONNECTION.

NOT FOR CONSTRUCTION

BIORETENTION COMPONENTS: CURB CUT AT BULBOUT INLET DETAIL



GREEN INFRASTRUCTURE
EXAMPLE DETAILS
ALAMEDA COUNTYWIDE CLEAN
WATER PROGRAM

SCALE: NOT TO SCALE	
DATE: MAY 11, 2018	REVISED: JUNE 11, 2019
DRAWN BY: K. K.	REVISED BY: E. F.
CHECKED BY: A. R.	

GI-6C

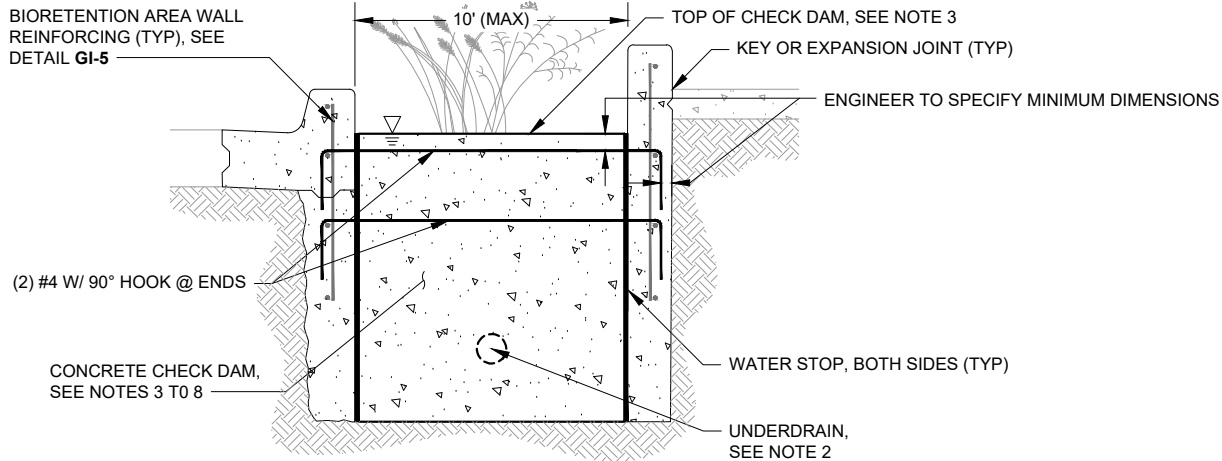

SECTION - CONCRETE CHECK DAM (1)

NOTES:

1. REFER TO GI-1 NOTES FOR GUIDELINES AND CHECKLIST.
2. UNDERDRAIN TO PASS THROUGH CHECK DAM IN NON-PERFORATED PIPE. PIPE FITTINGS SHALL BE USED TO ACCOMMODATE CHANGES IN GRADE, AS NEEDED.
3. HEIGHT AND SPACING OF CHECK DAMS SHALL BE ESTABLISHED BASED ON THE PONDING DEPTH REQUIRED TO MEET PROJECT HYDROLOGIC PERFORMANCE GOALS AND THE MAXIMUM DESIRED DROP FROM THE SURROUNDING GRADE TO THE FACILITY BOTTOM.
4. ALL MATERIAL AND WORKMANSHIP FOR CHECK DAM ASSEMBLY SHALL CONFORM TO LOCAL JURISDICTION STANDARD SPECIFICATIONS.
5. CONCRETE CHECK DAM SHALL BE CONTINUOUS (NO JOINTS) AND REINFORCED WITH #4 BAR, PLACED AT 18" ON CENTER, EACH WAY.
6. CONCRETE CHECK DAM SHALL BE DESIGNED BY THE ENGINEER AND MEET STRUCTURAL REQUIREMENTS FOR LATERAL BRACING WHEN USED AS LATERAL BRACING.
7. TOP OF CHECK DAM TO BE LEVEL WITH CREST ELEVATION MATCHING PONDING ELEVATION UNLESS NOTCH SIZED TO CONVEY DESIGN FLOWS PROVIDED.
8. GROUT ALL PENETRATIONS, CRACKS, SEAMS, AND JOINTS WITH CLASS "C" MORTAR.

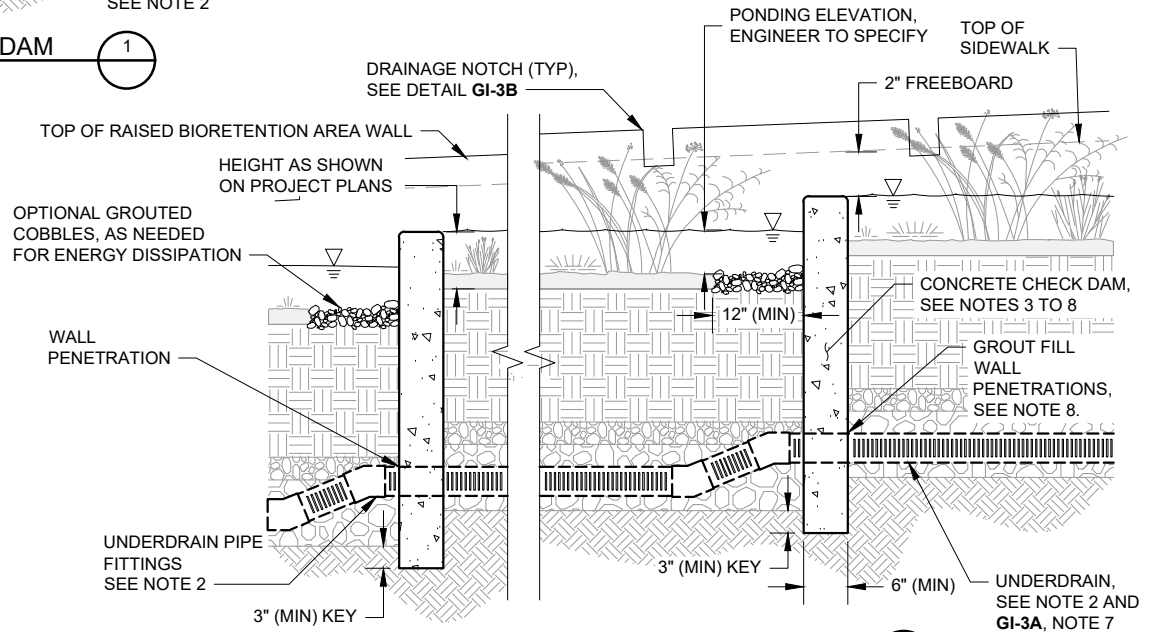

PROFILE - CONCRETE CHECK DAM (2)

NOT FOR CONSTRUCTION

BIORETENTION COMPONENTS: CHECK DAM DETAIL

GREEN INFRASTRUCTURE
EXAMPLE DETAILS
ALAMEDA COUNTYWIDE CLEAN
WATER PROGRAM

SCALE: NOT TO SCALE
DATE: MAY 11, 2018 REVISED: JUNE 11, 2019
DRAWN BY: K. K. REVISED BY: E. F.
CHECKED BY: A. R.

GI-7

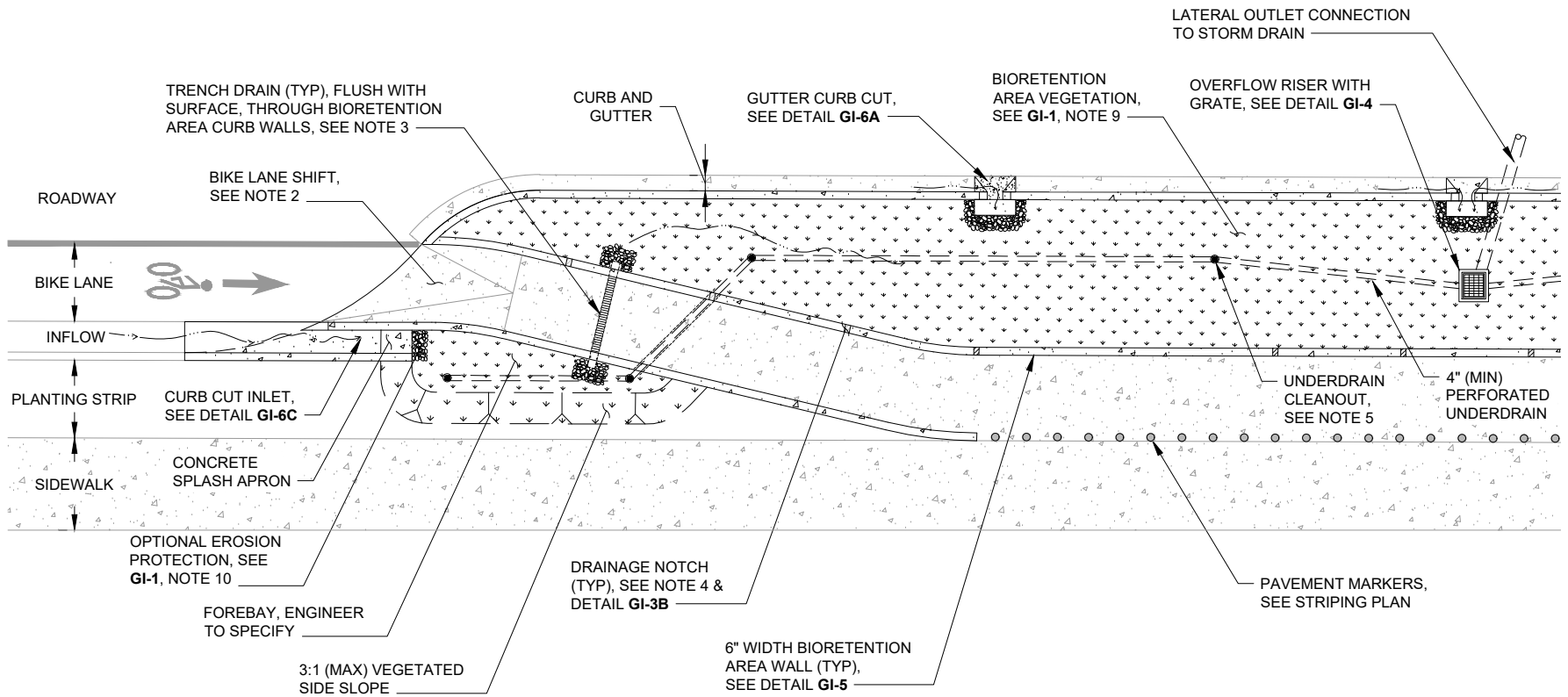

NOTES:

1. REFER TO GI-1 NOTES FOR GUIDELINES AND CHECKLIST.
2. RAMP BIKE LANE UP ONTO BULBOUT AND SHIFT LANE OVER. MAXIMUM 1:5 HORIZONTAL TRANSITION RATE. TRANSITION GEOMETRY SHALL CONFORM TO LOCAL JURISDICTION STANDARDS.
3. HYDRAULIC CONNECTION OF SEPARATED BIORETENTION AREAS PROVIDED BY TRENCH DRAINS. ENGINEER TO SPECIFY, FOLLOWING FLOW AND STRUCTURAL REQUIREMENTS.
4. LAY OUT DRAINAGE NOTCHES AS APPLICABLE TO PREVENT PONDING BEHIND BIORETENTION AREA WALL WITH 5' MAXIMUM SPACING BETWEEN NOTCHES.
5. PROVIDE ONE UNDERDRAIN CLEANOUT PER BIORETENTION AREA (MIN). CLEANOUT REQUIRED AT UPSTREAM END AND PIPE ANGLE POINTS EXCEEDING 45 DEGREES. LONGITUDINAL SLOPE OF PIPE SHALL BE 0.5% (MIN). PIPE SLEEVES REQUIRED FOR UNDERDRAINS TRANSITIONING BETWEEN BIORETENTION AREAS.
6. DRAWING GI-XX MODIFIED FROM THE BASMAA URBAN GREENING BAY AREA TYPICAL GI DETAILS FIGURE C-1.4.

NOT FOR CONSTRUCTION

BIORETENTION AREA: WITH BIKE LANE PLAN VIEW



GREEN INFRASTRUCTURE
EXAMPLE DETAILS
ALAMEDA COUNTYWIDE CLEAN
WATER PROGRAM

SCALE: NOT TO SCALE
DATE: MAY 11, 2018 REVISED: JUNE 11, 2019
DRAWN BY: K. K. REVISED BY: E. F.
CHECKED BY: A. R.

GI-8

Specification of soils for Biotreatment or Bioretention Facilities

Soils for biotreatment or bioretention areas shall meet two objectives:

- Be sufficiently permeable to infiltrate runoff at a minimum rate of 5" per hour during the life of the facility, and
- Have sufficient moisture retention to support healthy vegetation.

Achieving both objectives with an engineered soil mix requires careful specification of soil gradations and a substantial component of organic material (typically compost).

Local soil products suppliers have expressed interest in developing 'brand-name' mixes that meet these specifications. At their sole discretion, municipal construction inspectors may choose to accept test results and certification for a 'brand-name' mix from a soil supplier.

Tests must be conducted within 120 days prior to the delivery date of the bioretention soil to the project site.

Batch-specific test results and certification shall be required for projects installing more than 100 cubic yards of bioretention soil.

SOIL SPECIFICATIONS

Bioretention soils shall meet the following criteria. "Applicant" refers to the entity proposing the soil mixture for approval by a Permittee.

1. General Requirements – Bioretention soil shall:
 - a. Achieve a long-term, in-place infiltration rate of at least 5 inches per hour.
 - b. Support vigorous plant growth.
 - c. Consist of the following mixture of fine sand and compost, measured on a volume basis:
 - 60%-70% Sand
 - 30%-40% Compost
2. Submittal Requirements – The applicant shall submit to the Permittee for approval:
 - a. A minimum one-gallon size sample of mixed bioretention soil.
 - b. Certification from the soil supplier or an accredited laboratory that the Bioretention Soil meets the requirements of this guideline specification.
 - c. Grain size analysis results of the fine sand component performed in accordance with ASTM D 422, Standard Test Method for Particle Size Analysis of Soils or Caltrans Test Method (CTM) C202.
 - d. Quality analysis results for compost performed in accordance with Seal of Testing Assurance (STA) standards, as specified in 4.
 - e. Organic content test results of mixed Bioretention Soil. Organic content test shall be performed in accordance with by Testing Methods for the Examination of Compost and Composting (TMECC) 05.07A, "Loss-On-Ignition Organic Matter Method".
 - f. Grain size analysis results of compost component performed in accordance with ASTM D 422, Standard Test Method for Particle Size Analysis of Soils.
 - g. A description of the equipment and methods used to mix the sand and compost to produce Bioretention Soil.

h. Provide the name of the testing laboratory(s) and the following information:

- (1) Contact person(s)
- (2) Address(s)
- (3) Phone contact(s)
- (4) E-mail address(s)
- (5) Qualifications of laboratory(s), and personnel including date of current certification by USCC, ASTM, Caltrans, or approved equal

3. Sand for Bioretention Soil

- a. Sand shall be free of wood, waste, coating such as clay, stone dust, carbonate, etc., or any other deleterious material. All aggregate passing the No. 200 sieve size shall be nonplastic.
- b. Sand for Bioretention Soils shall be analyzed by an accredited lab using #200, #100, #40 or #50, #30, #16, #8, #4, and 3/8 inch sieves (ASTM D 422, CTM 202 or as approved by municipality), and meet the following gradation:

Sieve Size	Percent Passing (by weight)	
	<i>Min</i>	<i>Max</i>
3/8 inch	100	100
No. 4	90	100
No. 8	70	100
No. 16	40	95
No. 30	15	70
No. 40 or No.50	5	55
No. 100	0	15
No. 200	0	5

Note: all sands complying with ASTM C33 for fine aggregate comply with the above gradation requirements.

4. Composted Material

Compost shall be a well decomposed, stable, weed free organic matter source derived from waste materials including yard debris, wood wastes or other organic materials not including manure or biosolids meeting the standards developed by the US Composting Council (USCC). The product shall be certified through the USCC Seal of Testing Assurance (STA) Program (a compost testing and information disclosure program).

- a. Compost Quality Analysis by Laboratory – Before delivery of the soil, the supplier shall submit a copy of lab analysis performed by a laboratory that is enrolled in the US Composting Council’s Compost Analysis Proficiency (CAP) program and using approved Test Methods for the Examination of Composting and Compost (TMECC). The lab report shall verify:
 - (1) Organic Matter Content: 35% - 75% by dry wt.
 - (2) Carbon and Nitrogen Ratio: C:N < 25:1 and C:N >15:1
 - (3) Maturity/Stability: Any one of the following is required to indicate stability:
 - (i) Oxygen Test < 1.3 O₂ /unit TS /hr
 - (ii) Specific oxy. Test < 1.5 O₂ / unit BVS /hr
 - (iii) Respiration test < 8 mg CO₂-C /g OM / day
 - (iv) Dewar test < 20 Temp. rise (°C) e.
 - (v) Solvita® > 5 Index value
 - (4) Toxicity: Any one of the following measures is sufficient to indicate non-toxicity.
 - (i) NH₄⁺ : NO₃⁻-N < 3
 - (ii) Ammonium < 500 ppm, dry basis
 - (iii) Seed Germination > 80 % of control
 - (iv) Plant Trials > 80% of control
 - (v) Solvita® = 5 Index value
 - (5) Nutrient Content: provide analysis detailing nutrient content including N-P-K, Ca, Na, Mg, S, and B.
 - (i) Total Nitrogen content 0.9% or above preferred.
 - (ii) Boron: Total shall be <80 ppm;
 - (6) Salinity: Must be reported; < 6.0 mmhos/cm
 - (7) pH shall be between 6.2 and 8.2 May vary with plant species.
- b. Compost Quality Analysis by Compost Supplier – Before delivery of the compost to the soil supplier the Compost Supplier shall verify the following:
 - (1) Feedstock materials shall be specified and include one or more of the following: landscaping/yard trimmings, grass clippings, food scraps, and agricultural crop residues.
 - (2) Maturity/Stability: shall have a dark brown color and a soil-like odor. Compost exhibiting a sour or putrid smell or containing recognizable grass or leaves, or is hot (120F) upon delivery or rewetting is not acceptable.
 - (3) Weed seed/pathogen destruction: provide proof of process to further reduce pathogens (PFRP). For example, turned windrows must reach min. 55C for 15 days with at least 5 turnings during that period.
- c. Compost for Bioretention Soil Texture – Compost for bioretention soils shall be analyzed by an accredited lab using #200, 1/4 inch, 1/2 inch, and 1 inch sieves (ASTM D 422 or as approved by municipality), and meet the following gradation:

Sieve Size	Percent Passing (by weight)	
	<i>Min</i>	<i>Max</i>

1 inch	99	100
1/2 inch	90	100
1/4 inch	40	90
No. 200	1	10

- d. Bulk density shall be between 500 and 1100 dry lbs/cubic yard
- e. Moisture content shall be between 30% - 55% of dry solids.
- f. Inerts – compost shall be relatively free of inert ingredients, including glass, plastic and paper, < 1 % by weight or volume.
- g. Select Pathogens – Salmonella <3 MPN/4grams of TS, or Coliform Bacteria <10000 MPN/gram.
- h. Trace Contaminants Metals (Lead, Mercury, Etc.) – Product must meet US EPA, 40 CFR 503 regulations.
- i. Compost Testing – The compost supplier will test all compost products within 120 calendar days prior to application. Samples will be taken using the STA sample collection protocol. (The sample collection protocol can be obtained from the U.S. Composting Council, 4250 Veterans Memorial Highway, Suite 275, Holbrook, NY 11741 Phone: 631-737-4931, www.compostingcouncil.org). The sample shall be sent to an independent STA Program approved lab. The compost supplier will pay for the test.

VERIFICATION OF ALTERNATIVE BIORETENTION SOIL MIXES

Bioretention soils not meeting the above criteria shall be evaluated on a case by case basis. Alternative bioretention soil shall meet the following specification: “Soils for bioretention facilities shall be sufficiently permeable to infiltrate runoff at a minimum rate of 5 inches per hour during the life of the facility, and provide sufficient retention of moisture and nutrients to support healthy vegetation.”

The following steps shall be followed by municipalities to verify that alternative soil mixes meet the specification:

- 1. General Requirements – Bioretention soil shall achieve a long-term, in-place infiltration rate of at least 5 inches per hour. Bioretention soil shall also support vigorous plant growth. The applicant refers to the entity proposing the soil mixture for approval.
 - a. Submittals – The applicant must submit to the municipality for approval:
 - (1) A minimum one-gallon size sample of mixed bioretention soil.
 - (2) Certification from the soil supplier or an accredited laboratory that the Bioretention Soil meets the requirements of this guideline specification.

- (3) Certification from an accredited geotechnical testing laboratory that the Bioretention Soil has an infiltration rate between 5 and 12 inches per hour as tested according to Section 1.b.(2)(ii).
- (4) Organic content test results of mixed Bioretention Soil. Organic content test shall be performed in accordance with by Testing Methods for the Examination of Compost and Composting (TMECC) 05.07A, “Loss-On-Ignition Organic Matter Method”.
- (5) Grain size analysis results of mixed bioretention soil performed in accordance with ASTM D 422, Standard Test Method for Particle Size Analysis of Soils.
- (6) A description of the equipment and methods used to mix the sand and compost to produce Bioretention Soil.
- (7) The name of the testing laboratory(s) and the following information:
 - (i) Contact person(s)
 - (ii) Address(s)
 - (iii) Phone contact(s)
 - (iv) E-mail address(s)
 - (v) Qualifications of laboratory(s), and personnel including date of current certification by STA, ASTM, or approved equal.

b. Bioretention Soil

- (1) Bioretention Soil Texture: Bioretention Soils shall be analyzed by an accredited lab using #200, and 1/2” inch sieves (ASTM D 422 or as approved by municipality), and meet the following gradation:

Sieve Size	Percent Passing (by weight)	
	<i>Min</i>	<i>Max</i>
1/2 inch	97	100
No. 200	2	5

- (2) Bioretention Soil Permeability testing: Bioretention Soils shall be analyzed by an accredited geotechnical lab for the following tests:
 - (i) Moisture – density relationships (compaction tests) shall be conducted on bioretention soil. Bioretention soil for the permeability test shall be compacted to 85 to 90 percent of the maximum dry density (ASTM D1557).
 - (ii) Constant head permeability testing in accordance with ASTM D2434 shall be conducted on a minimum of two samples with a 6-inch mold and vacuum saturation.

MULCH FOR BIORETENTION FACILITIES

Three inches of mulch is recommended for the purpose of retaining moisture, preventing erosion and minimizing weed growth. Projects subject to the State’s Model Water Efficiency Landscaping Ordinance (or comparable local ordinance) will be required to provide at least three inches of mulch. Aged mulch, also called compost mulch, reduces the ability of weeds to establish, keeps soil moist, and replenishes soil nutrients. Aged mulch can be obtained through soil suppliers or directly from commercial recycling yards. It is recommended to apply 1" to 2" of composted mulch, once a year, preferably in June following weeding.

Attachment B-5: Capital Improvement Projects Sign-off Form

The Clean Water Program's Capital Improvement Projects Sign-off Form is provided on the following page. This form is used by the agency to document whether a Regulated Project (as defined in Provision C.3.b) has complied with Provision C.3 requirements, and whether a non-Regulated Project has been evaluated for green infrastructure (GI) potential.

This page intentionally left blank



How to Use the

C.3 Stormwater Compliance Sign-off Form for Capital Improvement Program (CIP) Projects

Introduction

The attached checklist is for Alameda Countywide Clean Water Program (Clean Water Program) member agencies to document that capital improvement program (CIP) projects either are exempt or have complied with the requirements for C.3 Regulated Projects, as defined in Provision C.3.b of the Municipal Regional Stormwater Permit (MRP), issued by the San Francisco Bay Regional Water Quality Control Board on November 19, 2015.

Step-by-Step Instructions

1. Fill out the project information at the top of the form (Project Name, Address, etc.)
2. Review the project description and the square footage of impervious surfaces that will be created and/or replaced by the project to determine whether the project may meet any of the conditions identified in the form, under the heading, "Project is NOT a C.3 Regulated Project and the Review of GI Potential Is Documented." If the project meets any of those conditions, check the appropriate box (or boxes).
 - ▶ If one or more boxes are checked, the project is NOT a C.3 Regulated Project. Continue to Step 3.
 - ▶ If no boxes are checked, the project IS a C.3 Regulated Project. Skip to Step 4.
3. Refer to the Clean Water Program's Worksheet for Identifying GI Potential in Municipal CIP Projects¹ (or your agency's equivalent worksheet or form) to evaluate the project for the potential to include green infrastructure (GI). In the C.3 Stormwater Compliance Sign-off Form for CIP Projects, under the subheading, "Green Infrastructure Potential Review," check the box to indicate the name of the worksheet or form that was used for this review, and indicate the date on which the worksheet or form was completed.
 - ▶ Skip to Step 5.
4. Refer to the project's stormwater control plan, construction documents, and/or other project documentation, such as a completed Stormwater Requirements Checklist², to determine whether the requirements for C.3 Regulated Projects have been met. If all requirements have been met, including the hydromodification management (HM) requirements in Provision C.3.g (if applicable) and the documentation of operation and maintenance responsibility as required by Provision C.3.h.ii.(1), check the box to indicate the name of the applicable document(s), and write the date of the document(s).
 - ▶ Continue to Step 5.
5. Sign and date the completed C.3 Stormwater Compliance Sign-off Form for CIP Projects.

¹ The worksheet is available on the New Development Subcommittee's members only website at: <https://cleanwaterprogram.org/index.php/committees/new-development-committee.html>.

² The checklist is available on the Clean Water Program's public website at: <https://cleanwaterprogram.org/>. Click on "Resources," then "Development," and scroll down to "Stormwater Requirements Checklist."



C.3 Stormwater Compliance Sign-off Form for Capital Improvement Program (CIP) Projects

This form references Provision C.3 of the Municipal Regional Stormwater Permit (MRP), issued by the San Francisco Bay Regional Water Quality Control Board on November 19, 2015.

Project Name: _____

Project Address: _____ APN: _____

Contact Person: _____

Contact Phone: _____ Contact Email: _____

Project is NOT a C.3 “Regulated Project” and the Review of “GI Potential” Is Documented.

C.3 “Regulated Project” Review

The project is NOT a C.3 “Regulated Project” based on the Regulated Project definitions in Provision C.3.b as indicated below. Please check the applicable box(es):

- Project would create and/or replace less than 5,000 square feet of impervious area.
- Project would create and/or replace less than 10,000 square feet of impervious area **AND** project does not include auto service/maintenance facilities, restaurants, uncovered parking areas (stand-alone or as part of a larger project), or structures with rooftop parking.
- Project is a Road Project **AND** project would construct less than 10,000 square feet of new contiguous impervious area when the following are excluded from the calculation:³
 - o Sidewalks built as part of new streets or roads that direct stormwater runoff to adjacent vegetated areas.
 - o Bicycle lanes built as part of new streets or roads that are not hydraulically connected to the new streets or roads and that direct stormwater runoff to adjacent impervious areas.
 - o Impervious trails that are:
 - A. less than 10 feet wide and more than 50 feet away from the top of a creek bank.

OR

 - B. designed to direct stormwater runoff to adjacent vegetated areas or other non-erodible permeable areas (preferably away from creeks or towards the outboard side of levees).
 - o Sidewalks, bicycle lanes, or trails constructed with permeable surfaces (pervious concrete, porous asphalt, unit pavers, or granular materials).
 - o Caltrans highway projects and associated facilities.
- Project consists of interior remodel.
- Project consists of routine maintenance and repairs (e.g., roof replacement, replacement of exterior wall surface, and/or pavement resurfacing) within the existing footprint.

³ *When calculating the impervious area of a Road Project, include all roadway surfaces related to creation of additional traffic lanes (including, for example, passing lanes and turning pockets). Shoulders and widened portion of existing lanes may be excluded from the calculation.*

“Green Infrastructure (GI) Potential” Review

Capital improvement program (CIP) projects that are NOT C.3 Regulated Projects must be reviewed to determine whether they have green infrastructure (GI) potential, as required in Provision C.3.j.ii.(2). When conducting these reviews, agencies should follow the Bay Area Municipal Stormwater Management Agencies Association’s (BASMAA) Guidance for Identifying GI Potential in Municipal CIP Projects. One way to follow this guidance is to use the Clean Water Program’s Worksheet for Identifying GI Potential in Municipal CIP Projects. These documents can be downloaded from www.cleanwaterprogram.com (click “Resources,” then “Development”). Please attach documentation to demonstrate that the project was reviewed for GI potential.

The non-C.3 Regulated Project has been reviewed for GI potential as shown in the following document(s):

- Worksheet for Identifying GI Potential in Municipal CIP Projects, dated: _____
- Other documentation (describe): _____

Project IS a C.3 “Regulated Project” — Compliance Documented.

The C.3 Regulated Project has met all requirements for C.3 Regulated Projects as shown in the following documents:

- Stormwater Control Plan, dated: _____
- Construction Documents, dated: _____
- Other documentation (describe): _____

Signature

Date

Name

Title

This page intentionally left blank

Attachment B-6: Guidance for Sizing Green Infrastructure Facilities in Street Projects

The Guidance for Sizing Green Infrastructure Facilities in Street Projects, provided by the Bay Area Stormwater Management Agencies Association (BASMAA), is included on the following page of paper copies of this green infrastructure (GI) Plan. The electronic version of this GI Plan includes the Guidance for Sizing Green Infrastructure Facilities in Street Projects as a stand-alone electronic file; an attachment to the BASMAA guidance is included as an additional stand-alone electronic file.

This page intentionally left blank

***Guidance for Sizing Green Infrastructure
Facilities in Street Projects***

with companion analysis:

***Green Infrastructure Facility Sizing for
Non-Regulated Street Projects***

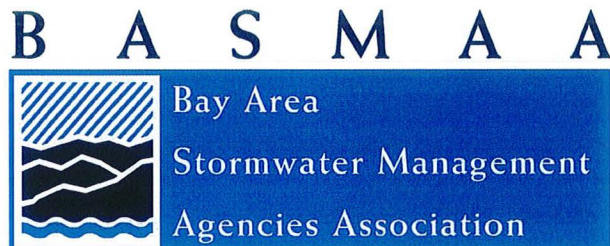

Prepared by
Dan Cloak Environmental Consulting
EOA, Inc.

June 2019

Introduction and Regulatory Background

Provision C.3.j. in the reissued Municipal Regional Stormwater Permit¹ (MRP) requires each Permittee to “complete and implement a Green Infrastructure (GI) Plan for the inclusion of low impact development drainage design into storm drain infrastructure on public and private lands, including streets, roads, storm drains, parking lots, building roofs, and other storm drain infrastructure elements.”

Provision C.3.j.i.(g) further mandates that these plans include:

Requirements that projects be designed to meet the treatment and hydromodification sizing requirements in Provisions C.3.c. and C.3.d. For street projects not subject to Provision C.3.b.ii. (i.e., non-Regulated Projects) Permittees may collectively propose a single approach with their Green Infrastructure Plans for how to proceed should project constraints preclude fully meeting the C.3.d. sizing requirements. The single approach can include different options to address specific issues or scenarios. That is, the approach shall identify the specific constraints that would preclude meeting the sizing requirements and the design approach(es) to take in that situation. The approach should also consider whether a broad effort to incorporate hydromodification controls into green infrastructure, even where not otherwise required, could significantly improve creek health and whether such implementation may be appropriate, plus all other information as appropriate (e.g., how to account for load reduction for the PCBs or mercury TMDLs).

This document represents the “single approach” collectively proposed by the Permittees for how to proceed when constraints on GI projects affect facility sizing in street projects. For other types of projects, information on hydraulic sizing is provided in the technical guidance manuals for Provision C.3 developed by each countywide stormwater program.

Hydraulic Sizing Requirements

MRP Provision C.3.d contains criteria for sizing stormwater treatment facilities. Facilities may be sized on the basis of flow, volume, or a combination of flow and volume. With adoption of the 2009 MRP, a third option for sizing stormwater treatment facilities was added to Provision C.3.d. This option states that “treatment systems that use a combination of flow and volume capacity shall be sized to treat at least 80 percent of the total runoff over the life of the project, using local rainfall data.”

This option can also be used to develop sizing factors for facilities with a standard cross-section (i.e., where the volume available to detain runoff is proportional to facility surface area). To calculate sizing factors, inflows, storage, infiltration to groundwater, underdrain discharge, and overflows are tracked for each time-step during a long-term simulation. The continuous simulation is repeated, with variations in the treatment surface area, to determine the minimum area required for the facility to capture and treat 80% of the inflow during the simulation.

¹ Order R2-2015-0049

Such an analysis was conducted for BASMAA by Dubin Environmental Consulting and is described in the attached Technical Report. The analysis shows that bioretention facilities with the current-standard cross-section can capture and treat the Provision C.3.d amount of runoff when sized to 1.5% - 3% of tributary equivalent impervious area, depending on location.

Hydromodification Management

A principal objective of LID is to mimic natural hydrology in the post-development condition. This is accomplished by retaining and infiltrating runoff flows during small to medium events. Flows from larger events are detained and slowed.

MRP Provision C.3.g. includes requirements and criteria for implementing hydromodification management (HM). These HM requirements apply to Regulated Projects that create or replace an acre or more of impervious area, increase the amount of impervious area over the pre-project condition, and flow to creeks that are at risk of erosion. As such, the HM requirements do not apply to street projects that retrofit drainage systems that receive runoff from existing roofs and paving.

However, Provision C.3.j.i.(g) states that the Permittees' approach to sizing GI facilities "...should also consider whether a broad effort to incorporate hydromodification controls into green infrastructure, even where not otherwise required, could significantly improve creek health and whether such implementation may be appropriate..."

Various criteria for HM design have been used in California and throughout the U.S. These criteria have been based on one or more of the following principles:

- Maintaining watershed processes
- Maintaining a site-specific water balance
- Maintaining the value of the curve number used in the NRCS method of computing peak runoff
- Controlling increases in peak flows from a specified storm size
- Controlling increases in the duration of flows at each intensity within a specified range (flow duration control)
- Controlling the likelihood of downstream erosion in streams (erosion potential, or Ep)

Generally, for any HM criterion used, facilities with more storage and a larger infiltrative area will be more effective in meeting the criterion than facilities with less storage and a smaller infiltrative area.

In the statewide municipal stormwater NPDES permit for small MS4s, Provision E.12.f. includes the following HM standard applicable to Bay Area small MS4s: "Post-project runoff shall not exceed estimated pre-project flow rate for the 2-year, 24-hour storm..."

Dubin (2014) conducted modeling to evaluate whether this standard would be met in the San Francisco Phase II counties (Marin, Sonoma, Napa, and Solano) by a bioretention facility meeting the minimum requirements in that permit's Provision

E.12.f. Dubin's analysis found that a facility sized to 4% of tributary equivalent impervious area, and having a 6-inch deep reservoir with 2 inches of freeboard, 18 inches of treatment soil, and a 12-inch-deep "dead storage" gravel layer below the underdrain, would meet this standard, even in the wettest portions of the Bay Area.

Additional Considerations for Bioretention Sizing

In summary, bioretention facilities for street projects sized to 1.5% - 3% of tributary equivalent impervious area (depending on their location in the Bay Area) can meet the criteria in Provision C.3.d., according to the modeling study documented in the attached Technical Memo.

There are many reasons to design and build facilities larger than the Provision C.3.d. minimum. Building larger facilities helps ensure the facilities perform to the minimum hydraulic capacity intended, despite minor flaws in design, construction, and maintenance, providing an engineering safety factor for the project. Further, larger-sized facilities may more effectively address objectives to maximize the removal of pollutants (particularly pollutants in dissolved form), to operate as full trash capture devices, and to manage hydromodification effects.

However, municipalities often face considerable challenges in retrofitting existing streetscapes with GI facilities. Constraints and design challenges typically encountered in the public right-of-way include:

- The presence of existing underground utilities (known and unknown during the design phase);
- The presence of existing above-ground fixtures such as street lights, fire hydrants, utility boxes, etc.;
- The presence of existing mature trees and root systems;
- The elevation of or lack of existing storm drains in the area to which to connect underdrains or overflow structures;
- Challenges of defining and controlling any catchment areas on adjacent private parcels that drain to the roadway surface;
- Low soil permeability and strength, and the need to protect the adjacent roadway structure;
- Competition with other assets & uses for limited right-of-way area; and
- Presence of archeologic/cultural deposits.

Use of the sizing factors in the attached Technical Memo will provide municipalities flexibility in design of bioretention facilities for street projects where constraints are present.

Recommendations for Sizing Approaches for Green Infrastructure Retrofit Facilities in Street Projects

1. Bioretention facilities in street projects should be sized as large as feasible and meet the C.3.d criteria where possible. Constraints in the public right-of-way may affect the size of these facilities and warrant the use of smaller sizing factors.

Bioretention facilities in street projects may use the sizing curves in the attached memorandum to meet the C.3.d criteria. Local municipal staff involved with other assets in the public right of way should be consulted to provide further guidance to design teams as early in the process as possible.

2. Bioretention facilities in street projects smaller than what would be required to meet the Provision C.3.d criteria may be appropriate in some circumstances. As an example, it might be appropriate to construct a bioretention facility where a small proportion of runoff is diverted from a larger runoff stream. Where feasible, such facilities can be designed as “off-line” facilities, where the bypassed runoff is not treated or is treated in a different facility further downstream. In these cases, the proportion of total runoff captured and treated should be estimated using the results of the attached memorandum. In cases where “in-line” bioretention systems cannot meet the C.3.d criteria, the facilities should incorporate erosion control as needed to protect the facility from high flows. See Figures 1 and 2 below for illustration of the in-line and off-line concepts.
3. Pollutant reduction achieved by GI facilities in street projects will be estimated in accordance with the Interim Accounting Methodologyⁱ or the applicable Reasonable Assurance Analysisⁱⁱ.



Figure 1: Off-line system in El Cerrito where low flow is diverted to the sidewalk planter and high flows continue down the gutter.



Figure 2: In-line system in Berkeley/Albany where low and high flows enter the system and overflows exit through a drain within the system.

ⁱ The Interim Accounting Methodology for TMDL Loads Reduced Report (BASMAA 2017) describes the methodology that is being used to demonstrate progress towards achieving the PCB and mercury load reductions required during the term of MRP 2.0. The methodology is based on the conversion of land use from a higher to a lower PCB or mercury loading rate during the redevelopment of a parcel. See:

[www.waterboards.ca.gov/sanfranciscobay/water_issues/programs/stormwater/Municipal/POC/Final%20Interim%20Accounting%20Methodology%20Report%20v.1.1%20\(Revised%20March%202017\).pdf](http://www.waterboards.ca.gov/sanfranciscobay/water_issues/programs/stormwater/Municipal/POC/Final%20Interim%20Accounting%20Methodology%20Report%20v.1.1%20(Revised%20March%202017).pdf)

ⁱⁱ A Reasonable Assurance Analysis (RAA) is a methodology used to demonstrate that implementation of pollutant control measures (such as GI facilities) over a specified time period will meet required pollutant load reductions associated with a TMDL. The Bay Area Reasonable Assurance Analysis Guidance Document (BASMAA 2017) establishes a regional framework and provides guidance for conducting PCBs and mercury RAAs in the San Francisco Bay Area. See: <http://basmaa.org/Announcements/bay-area-reasonable-assurance-analysis-guidance-document>

**BAY AREA
STORMWATER MANAGEMENT AGENCIES
ASSOCIATION**

**GREEN INFRASTRUCTURE
FACILITY SIZING FOR NON-REGULATED STREET
PROJECTS**

**Prepared by:
Dubin Environmental
December 13, 2017**



1. Introduction

The San Francisco Bay Regional Water Quality Control Board's reissued Phase I Municipal Regional Stormwater Permit (Order No. R2-2015-0049, issued 11/19/2015 and referred to as "MRP 2.0") includes a requirement that Permittees complete and implement green infrastructure plans to promote the increased use of green infrastructure in urban areas. These plans will guide the integration of green stormwater facilities into streets, parking lots, parks, building rooftops and similar places where there is an opportunity to retrofit traditional gray infrastructure systems and increase the removal of pollutants and improve water quality.

Provision C.3.j states:

Over the long term, the (Green Infrastructure) Plan is intended to describe how the Permittees will shift their impervious surfaces and storm drain infrastructure from gray, or traditional storm drain infrastructure where runoff flows directly into the storm drain and then the receiving water, to green—that is, to a more-resilient, sustainable system that slows runoff by dispersing it to vegetated areas, harvests and uses runoff, promotes infiltration and evapotranspiration, and uses bioretention and other green infrastructure practices to clean stormwater runoff.

Provision C.3.j.i.(2)(g) requires that projects be designed to meet the treatment and hydromodification sizing requirements in Provisions C.3.c. and C.3.d. However, the provision further states that for street projects that are not Regulated Projects:

...Permittees may collectively propose a single approach with their Green Infrastructure Plans for how to proceed should project constraints preclude fully meeting the C.3.d sizing requirements. The single approach can include different options to address specific issues or scenarios. That is, the approach shall identify the specific constraints that would preclude meeting the sizing requirements and the design approach(es) to take in that situation.

To address this provision and further define the C.3.d sizing requirements for green infrastructure projects, the Bay Area Stormwater Management Agencies Association (BASMAA) contracted with Dubin Environmental to conduct continuous simulation hydrologic modeling to evaluate relationships of facility size (e.g., area, depth, flow rate) to facility performance. The BASMAA Development Committee, and BASMAA member agencies, intend to use these relationships to develop and justify an approach, to be created by the Development Committee, for implementing green street projects when there are constraints on facility size.

This report describes the modeling analysis that was performed to better understand the relationship between bioretention configuration and annual runoff treatment across the different BASMAA stormwater agencies and their climate zones. Long-term continuous modeling was used to compute stormwater runoff, simulate bioretention hydraulics, and estimate the annual percentage of stormwater that is treated. The analysis was performed for 10 different rain gauges that together represent the full range of climate conditions across the BASMAA member agency area. The analysis also considered different bioretention configurations and treatment goals. BASMAA member agencies can use these results to help establish policies and design guidelines to include in their green infrastructure plans.

2. Project Approach

The performance of bioretention facilities was modeled using HSPF (Hydrologic Simulation Program Fortran), which is a physically based, hydrologic model that is maintained and distributed by the US EPA.

HSPF has been used since the 1970s to conduct hydrologic analyses and size stormwater and flood control facilities. For this project, an HSPF model was developed to simulate runoff from a fully paved, 1-acre reference site and route this flow through a bioretention facility. This section describes the rain gauge selection and the HSPF modeling approach. Section 3 describes the modeling results.

2.1 Rainfall and Evapotranspiration Data

There are more than two dozen rain gauges with long-term, hourly data located within the BASMAA area. A list of candidate gauges was prepared from the National Center for Environmental Information (NCEI; formerly the National Climate Data Center or NCDC) network and then evaluated for inclusion. The evaluation focused on gauge data that could be downloaded directly from EPA's National Stormwater Calculator, because these datasets have been reviewed and missing records filled with data from available nearby stations (similar to the data included with the EPA BASINS software). The list of candidate gauges was narrowed to 19 locations with 35+ years of data that are geographically distributed through the BASMAA area. The rain gauges were organized into tables that show a) mean annual precipitation (MAP) and b) 6-month, 1-year, and 2-year accumulations for 1-year and 24-hour durations. The different storm depth statistics were used to identify any outliers among the rain gauge data that could indicate problems that would hinder the effort to create regressions among the model results. The rain gauge locations were also plotted in ArcGIS.

The recommended sites were presented to the BASMAA project work group who provided helpful input about their preferences and experiences with different rain gauges. Based on this input, six stations were selected for inclusion in the modeling analysis. After developing the HSPF input and output routines, the number of gauges was increased to 10 by including higher rainfall locations to allow development of regression relationships that span the rainfall characteristics at any likely project location. Table 1 lists the candidate rain gauges included in the modeling analysis. For all gauges, a common 37 year period was used to eliminate the influence of drought and wet periods that occurred when some gauges were operational but not others. Figure 1 shows the mean annual rainfall and Figure 2 shows their locations. The 1-year and 24-hour storm durations are included in Appendix A.

TABLE 1. SELECTED RAIN GAUGES FOR GREEN INFRASTRUCTURE MODELING

Z	Name	County/Agency	Years of Record	Mean Annual Rain (in)
049001	Tracy Pumping Plant	Contra Costa	37	12.7
047821	San Jose	Santa Clara	37	15.2
045378	Martinez Water Plant	Contra Costa	37	19.6
047769	SF Airport	San Francisco	37	20.4
047772	SF Downtown	San Francisco	37	21.9
046336	Oakland Museum	Alameda	37	22.8
042934	Fairfield	Fairfield-Suisun	37	24.1
043714	Half Moon Bay	San Mateo	37	28.6
047807	San Gregorio	San Mateo	37	30.0
044500	Kentfield	Marin	37	48.1

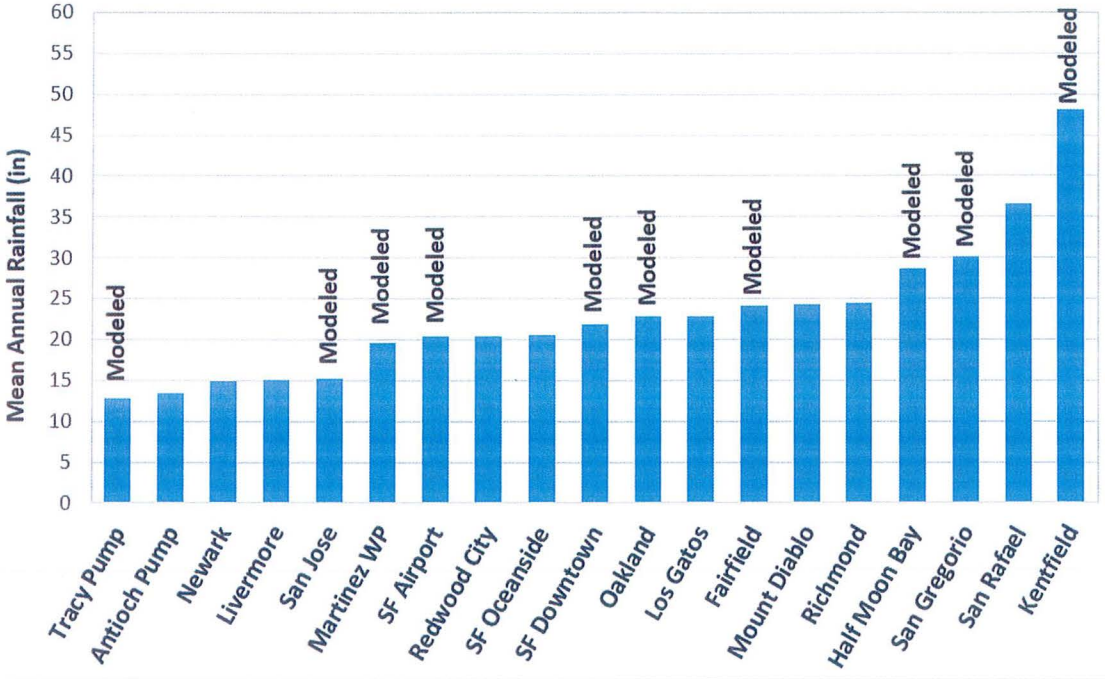

Figure 1. Candidate and selected rainfall sites with mean annual rainfall

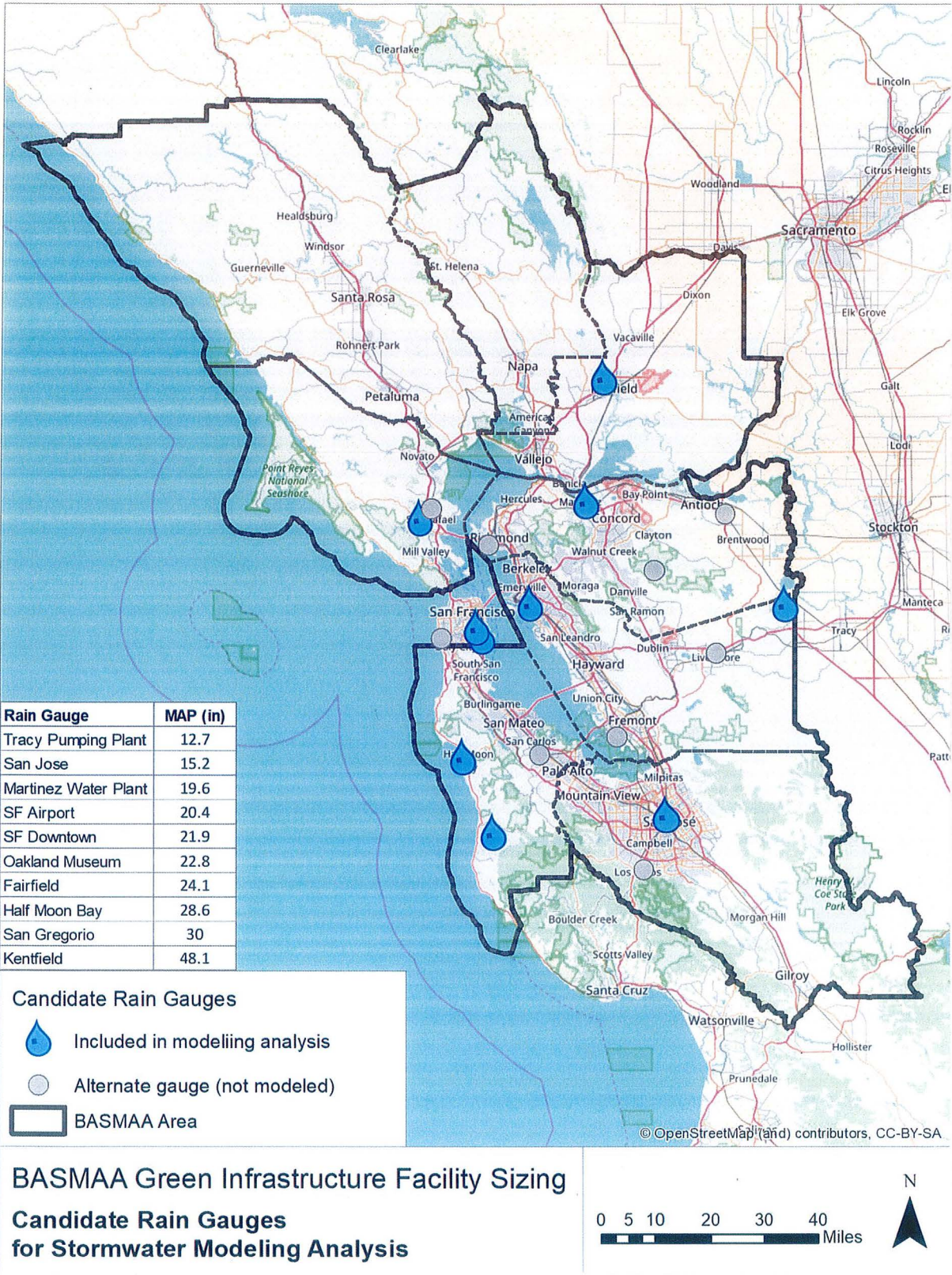

Figure 2. Location of rain gauges used in the modeling analysis

2.2 HSPF Model Setup

An HSPF model was developed to simulate runoff from a fully paved, 1-acre reference area and route this flow through a bioretention facility. The model outputs were then evaluated to determine the fraction of incoming stormwater receiving water quality treatment (defined as the fraction filtered through the bioretention media, evaporated or transpired). The HSPF model was developed with Excel/VBA-based code that enabled us to easily modify the rain gauge, bioretention area, and surface reservoir depth to determine how these watershed and configuration parameters affect the fraction of stormwater being treated.

The model parameters and approach to simulating bioretention hydraulics are discussed in detail below:

- Stormwater runoff flows across the reference 1-acre paved area and enters the bioretention facility. This water is initially detained in a shallow surface reservoir and then infiltrates to the bioretention media.
- Stormwater infiltrates through the bioretention media into an underlying gravel layer. The saturated soil permeability was set to 5 inches per hour (based on the media specification). For unsaturated soils, the relationship between soil moisture and permeability was based on monitoring data collected at three installations in Pittsburg (Contra Costa, 2013). The data showed very little infiltration occurs until the soil reaches about two-thirds saturation, and then infiltration increases roughly linearly until reaching 5 inches per hour at 90 percent saturation. Evapotranspiration also occurs in this layer.
- Stormwater within the gravel layer can move freely and infiltrate to surrounding soils, based on their capacity. If runoff enters the gravel layer more rapidly than it infiltrates, the saturation level in the gravel layer will rise until it reaches the elevation of a perforated pipe underdrain. When this occurs, water will flow through the underdrain to a downstream discharge point (typically the municipal storm drainage system).
- The surface reservoir is also equipped with an overflow structure that will become active if runoff enters the surface reservoir more rapidly than it infiltrates through the bioretention media and the surface reservoir fills to its maximum depth. Water discharged via the overflow relief structure does not receive treatment.

The bioretention configuration was based on the water quality treatment design criteria listed in the MRP 2.0 and accepted design practice in the Bay Area. Table 2 lists the dimensions of the bioretention layers as modeled in HPSF.

TABLE 2. BIORETENTION CHARACTERISTICS IN HSPF MODEL

Component	Characteristics
Surface reservoir	<ul style="list-style-type: none"> • Area = bioretention area (varies from 0.5% to 5% of upstream impervious area) • Depth = 6 or 12 inches with overflow relief set 2 inches from top of reservoir
Bioretention soil media	<ul style="list-style-type: none"> • Area = bioretention area • Depth = 18 inches • Saturated permeability = 5 inches per hour • Unsaturated permeability = variable, based on Contra Costa's 2013 monitoring data
Storage (gravel) layer	<ul style="list-style-type: none"> • Area = bioretention area • Depth = 12 inches • Permeability of surrounding soils = 0.024 inches per hour
Underdrain	<ul style="list-style-type: none"> • Located at top of gravel layer • Assumed 4-in diameter pipe

2.3 Model QA/QC Process

The HSPF input files and initial model results were carefully examined during the QA/QC process. Model errors and warnings were systematically eliminated and then the results were compared with the results generated from three independent calculation methods:

1. An Excel-based bioretention hydraulics calculator
2. A Matlab-based bioretention algorithm that was used for bioretention modeling in the Central Coast region
3. An EPA SWMM model using the LID module to represent bioretention hydraulics

The comparison was performed for the San Jose and Fairfield gauges with a bioretention sizing factor of 0.02 (i.e., bioretention surface area equal to 2 percent of the upstream impervious area). The estimated annual runoff treatment percentages agreed to within 3 percent, which confirmed the HSPF model was performing as intended.

3. Modeling Scenarios and Results

The HSPF modeling analysis was used to develop bioretention sizing criteria and support policy decisions. Working collaboratively with the BASMAA Development Committee, the modeling analysis addressed the following issues, which are presented in this section:

1. Bioretention area necessary to treat 80 percent of annual stormwater runoff
2. Relationships for estimating annual stormwater treatment percentage across a range of bioretention sizes and mean annual precipitation depths
3. Relationships for estimating annual stormwater treatment percentage for bioretention facilities without an underdrain
4. Bioretention treatment percentage for facilities with no infiltration to surrounding soils
5. Bioretention treatment percentage for facilities with lower bioretention media permeability

The results are summarized graphically here. The full set of results and underlying data were provided separately to the BASMAA Development Committee on 7/28/2017 and are available from BASMAA upon request.

3.1 Bioretention Sizing for Treatment of 80 Percent of Annual Runoff

The performance of bioretention facilities was modeled for 10 different rain gauges and bioretention footprint areas, ranging from 0.5 to 5.0 percent of the upstream tributary area, using the approach described in Section 2. Bioretention configurations with 6-inch and 12-inch deep surface reservoirs were modeled. For each of the model runs, the runoff treatment percentage was computed, and the results were plotted. Figure 3 shows an example for the San Jose gauge. Appendix B shows results for the other rain gauges.

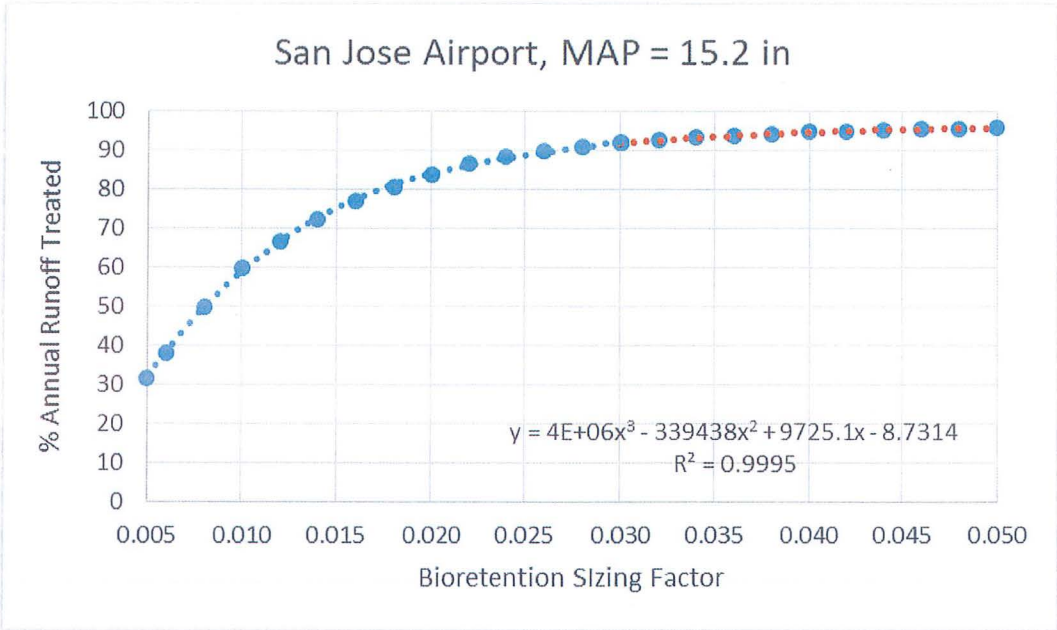

Figure 3. Percent of annual runoff treated for range of bioretention facility sizes using San Jose rain gauge

Using a polynomial regression equation, the model results for each rain gauge/surface reservoir depth scenario were interpolated to estimate the bioretention sizing factor needed to provide 80 percent annual runoff treatment, which is the treatment criterion for regulated water quality projects in the MRP 2.0. The results across the 10 rain gauges showed a clear linear relationship between mean annual rainfall and the bioretention footprint needed for 80 percent annual runoff treatment. Figure 4 and Figure 5 show the results for the 6-inch and 12-inch surface reservoir configurations, respectively.

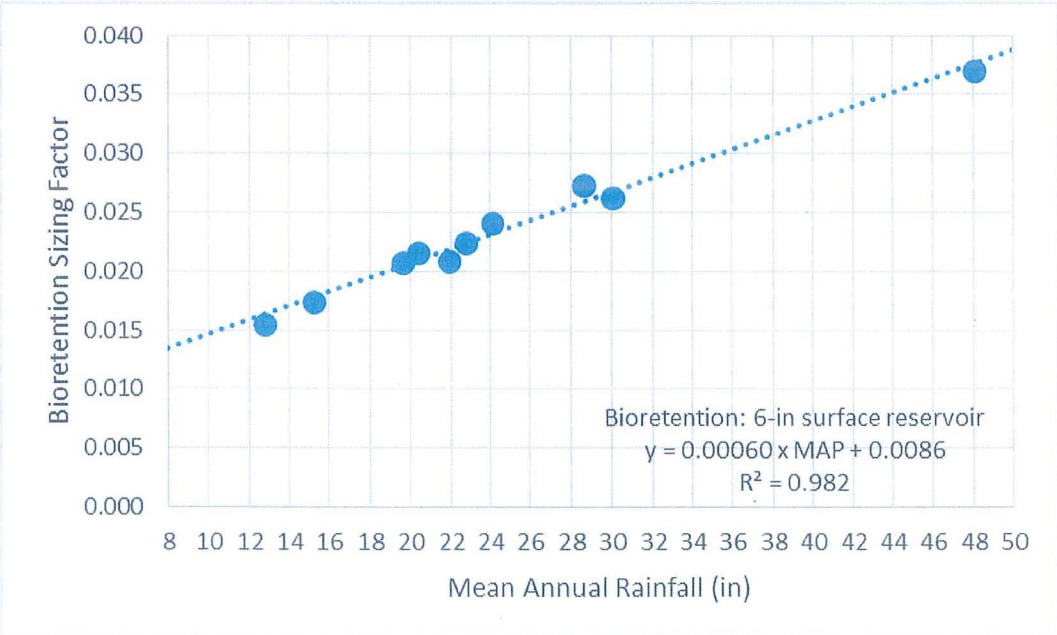

Figure 4. Bioretention size needed to provide treatment of 80 percent of annual runoff; 6-in surface reservoir

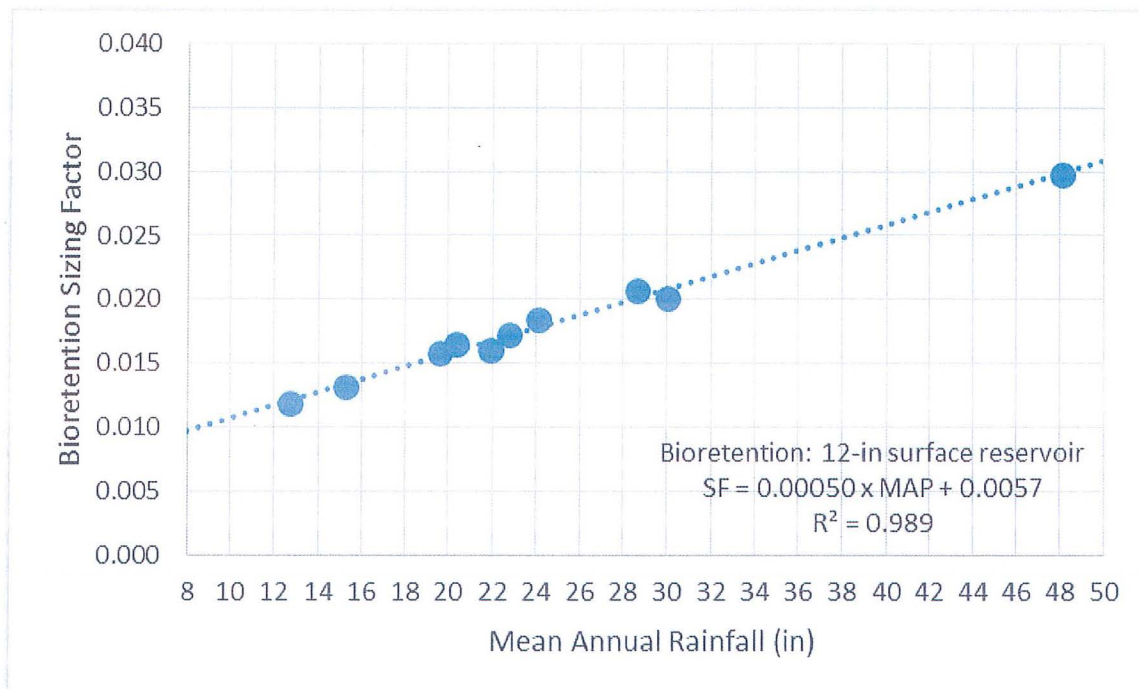

Figure 5. Bioretention size needed to provide treatment of 80 percent of annual runoff; 12-in surface reservoir

The results shown above could be used by BASMAA agencies to set minimum bioretention sizing criteria for projects that must provide treatment of 80 percent of annual runoff. The following equations could be included in BASMAA guidance for green infrastructure manuals.

For bioretention with 6-in surface reservoir configuration:

$$SizingFactor = 0.00060 \times MAP(in) + 0.0086$$

For bioretention with 12-in surface reservoir configuration:

$$SizingFactor = 0.00050 \times MAP(in) + 0.0057$$

3.2 Relationship Among Bioretention Sizing, Annual Precipitation, and Percent of Annual Runoff Treated

The modeling results generated in the previous section were then further evaluated to develop more general relationships among a) bioretention sizing factor, b) mean annual rainfall, and c) annual runoff treatment percentages. The following steps were used for the 6-inch and 12-inch reservoir depth configurations:

1. A polynomial regression was fit to the annual runoff treatment results for each of the 10 rain gauges (see example in Figure 3 above) and surface reservoir depths of 6 and 12 inches.
2. For each rain gauge/surface reservoir depth combination, the regression equation was used to estimate the sizing factors needed to provide 50, 60, 70, 80, 90, and 95 percent annual runoff treatment. This step generated 10 pairs of mean annual rainfall/bioretention sizing factor data for each rain gauge/surface reservoir depth combination (120 pairs in total). Excel's solver function was used for these calculations.

3. For each runoff treatment percentage level (50 percent, 60 percent, etc.), the mean annual rainfall (x-axis) and computed sizing factor (y-axis) were plotted and a linear regression was fit to the data in a manner similar to Figure 4 and Figure 5 above.
4. The linear regressions created for each runoff treatment level (50 percent, 60 percent, etc.) and surface reservoir depth were then plotted together to create a nomograph. Figure 6 and Figure 7 show nomographs for the 6-inch and 12-inch reservoir depths, respectively.

These nomographs are simple but powerful tools that municipal planners can use to estimate the annual treatment percentage for any bioretention facility within the BASMAA member agency area that uses the standard bioretention configuration (i.e., 6-in or 12-in reservoir, 18-in soil media, 12-in gravel layer, underdrain at top of gravel layer). The nomographs should be read as follows:

Step 1: Find the mean annual rainfall for the project location along the horizontal axis

Step 2: Move vertically up the chart to the bioretention sizing factor for the project/installation (note: this step assumes the tributary impervious area and bioretention area have already been planned)

Step 3: Visually interpolate between the closest two "treatment lines" to estimate the percent of annual runoff treated for this location/project.

These nomographs and instructions could be included in BASMAA guidance for green infrastructure manuals and used to a) evaluate the water quality benefits of proposed projects or b) evaluate the treatment provided by existing facilities with the layer depths described above.

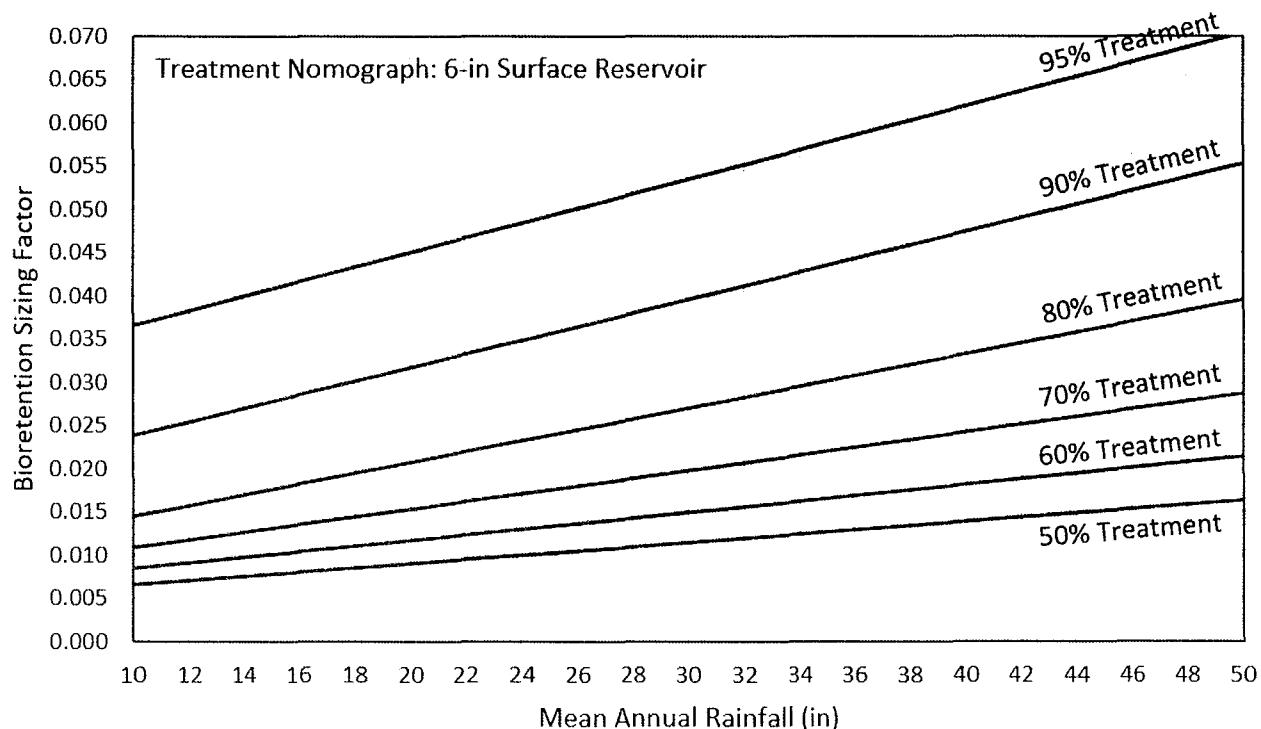

Figure 6. Percent of annual runoff treatment nomograph for bioretention facility with 6-in surface reservoir

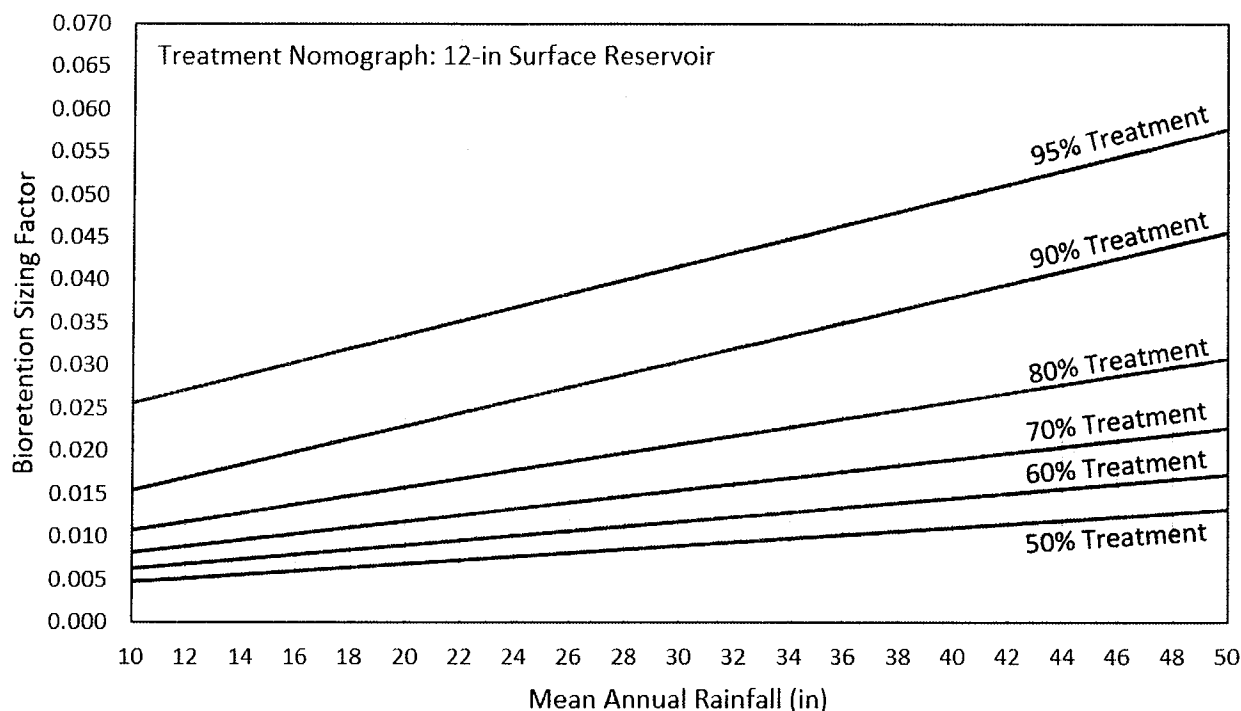

Figure 7. Percent of annual runoff treatment nomograph for bioretention facility with 12-in surface reservoir

3.3 Percent of Annual Runoff Treated by Bioretention Facilities with No Underdrain

Bioretention facilities are occasionally designed with no underdrain, including bioretention facilities in the following conditions:

- High permeability of surrounding (native) soils
- Isolated projects with no downstream drainage system for the underdrain connection
- Small projects that would not justify the additional design and construction costs associated with underdrains and cleanouts
- Projects that were designed and built prior to the development of the current standards

The HSPF model setup was modified to eliminate the underdrain outflows and allow the permeability of the surrounding soils to vary. The annual runoff treatment percentage was computed for a) three rain gauges representing drier, average and wetter than average conditions, b) six rates of permeability of surrounding soils, and c) two bioretention surface reservoir depths (Table 3).

TABLE 3. BIORETENTION WITH NO UNDERDRAIN SCENARIOS

Component	Characteristics
Rain gauges	<ul style="list-style-type: none"> • San Jose (MAP = 15.2 in) • San Francisco Airport (MAP = 20.4 in) • Fairfield (MAP = 24.1 in)
Permeability of surrounding (native) soils	<ul style="list-style-type: none"> • 0.2, 0.5, 1.0, 2.0, 3.0, 4.0 inches per hour • Underdrain results also plotted

TABLE 3. BIORETENTION WITH NO UNDERDRAIN SCENARIOS

Component	Characteristics
Surface reservoir depths	<ul style="list-style-type: none"> • Depth = 6 inches • Depth = 12 inches
Bioretention sizing factors	<ul style="list-style-type: none"> • Area = 0.5% to 5.0% of upstream impervious acre

Figure 8, Figure 9 and Figure 10 show the modeled annual runoff treatment results for the three rain gauges and a surface reservoir depth of 6 inches. Results for the 12-inch surface reservoir are shown in Appendix C. For rates of permeability of 4 inches per hour, there is little drop off in performance. The annual runoff treatment percentage declines gradually between rates of permeability of 2 to 4 inches per hour and then declines more rapidly for rates of permeability of 1 inch per hour or less. The reduction in performance is more pronounced in wetter areas (as seen in the Fairfield results). These results could be incorporated into the BASMAA guidance for green infrastructure manuals to assess the general performance of existing facilities that were installed with no underdrain.

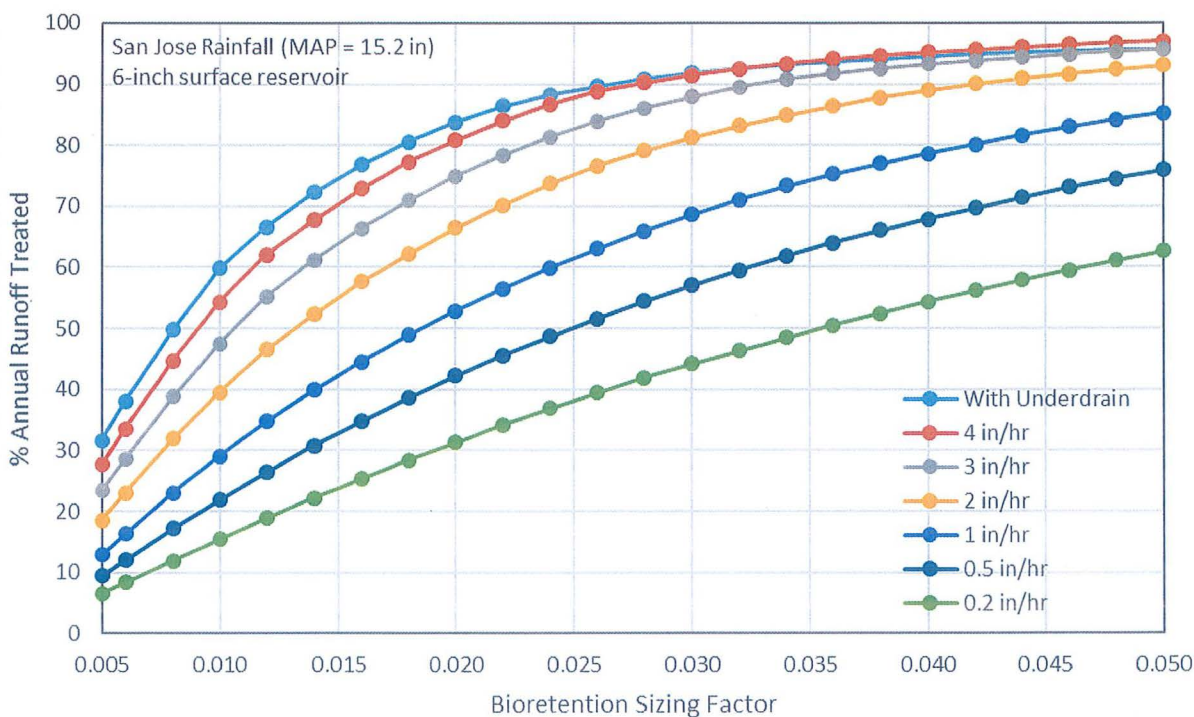

Figure 8. Treatment results for bioretention with no underdrain, San Jose gauge (MAP = 15.2 in), for varying rates of permeability of surrounding soils

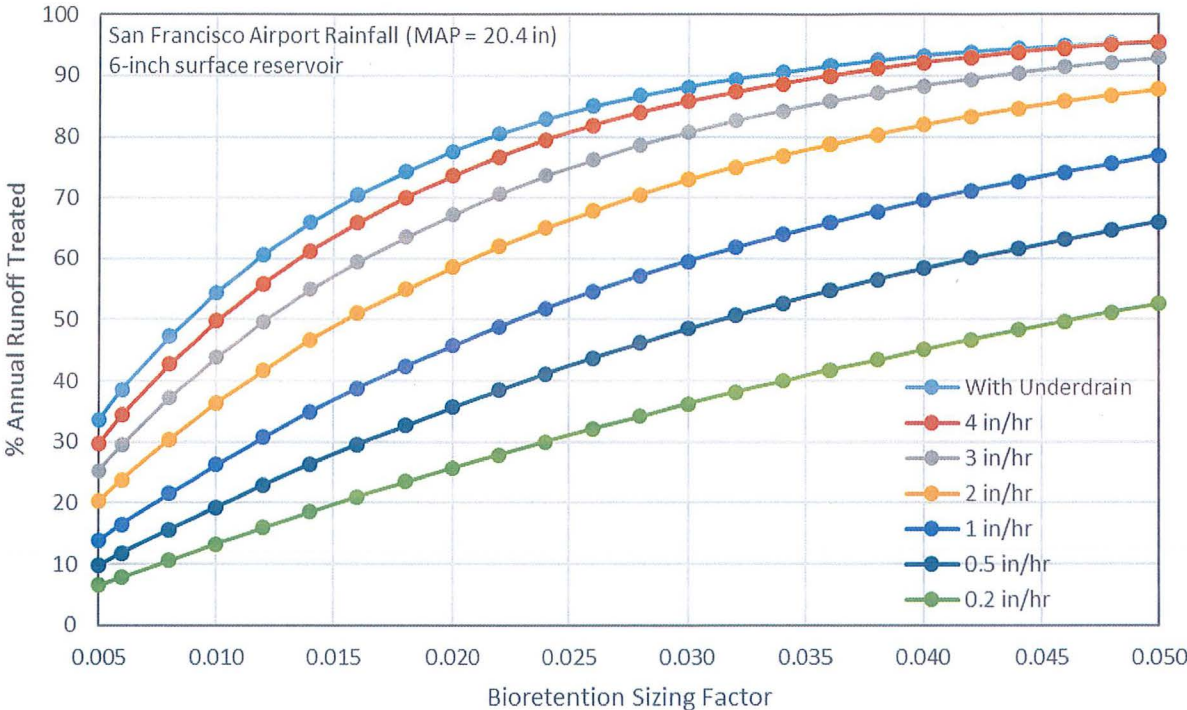

Figure 9. Treatment results for bioretention with no underdrain, San Francisco Airport gauge (MAP = 20.4 in), for varying rates of permeability of surrounding soils

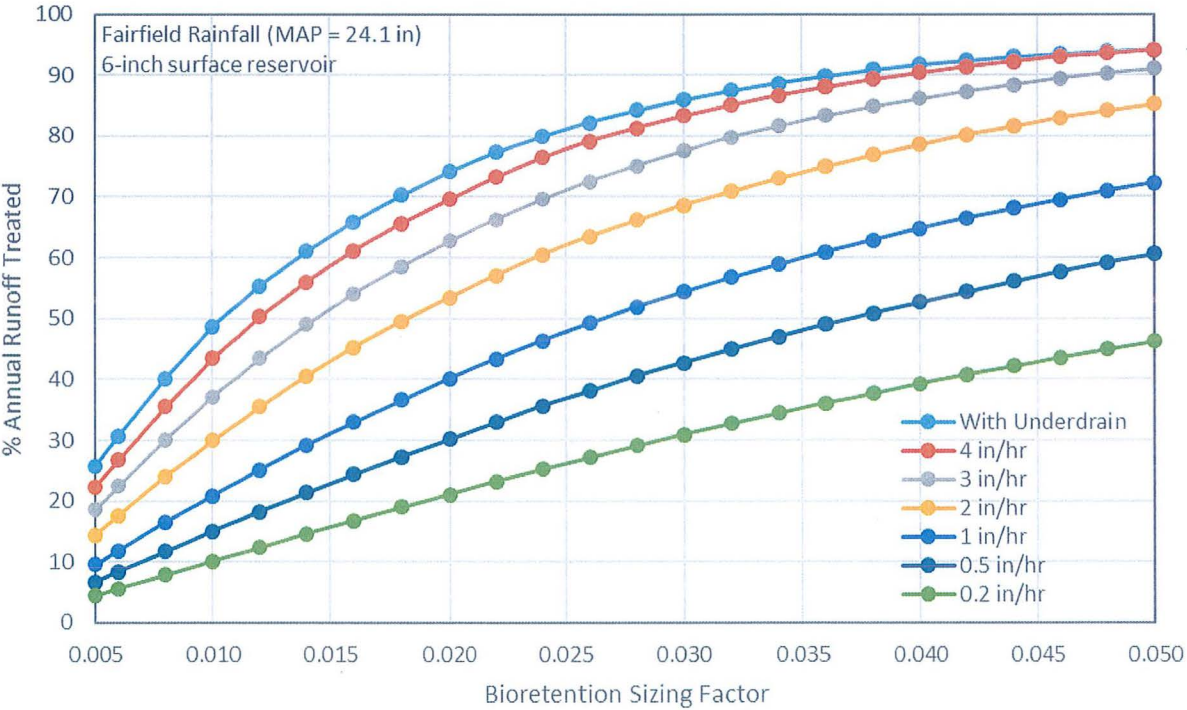

Figure 10. Treatment results for bioretention with no underdrain, Fairfield gauge (MAP = 24.1 in), for varying rates of permeability of surrounding soils

3.4 Percent of Annual Runoff Treated for Bioretention Facilities with No Infiltration to Surrounding Soils

The previous simulations described in Sections 3.1 and 3.2 were conducted for bioretention facilities located in NRCS hydrologic soil group D soils, which are low permeability soils, such as clays. These model simulations used a conservative permeability of 0.024 inches per hour from the bioretention gravel layer to surrounding soils. It was assumed the permeability of surrounding soils would have a negligible effect on the results because the hydraulic capacity of the underdrain is much higher than the permeability of D soils and that when the bioretention media becomes saturated, stormwater would exit mostly via the underdrain. If this assumption is correct, a lined bioretention facility or flow-through planter with no infiltration into surrounding soils should have similar performance.

This assumption was tested directly by running a limited number of simulations with the permeability of the surrounding soils set to a value of zero (i.e., an impervious layer directly below the bioretention facility). The annual treatment percentages were then compared to the previous modeling results (with D soil permeability set to 0.024 inches per hour). These simulations were performed for the Fairfield rain gauge and a bioretention facility with a 6-inch surface reservoir for sizing factors ranging from 0.005 to 0.050.

Figure 11 shows the two sets of model results. For the impermeable bottom scenario, the annual treatment percentage was on average 0.8 percent less the scenarios with a D soil permeability of 0.024 inches per hour (minimum difference = 0.4 percent; maximum difference = 1.5 percent). Therefore, the sizing curves and nomographs in Figure 4 through Figure 7 can be used for lined facilities with no infiltration.

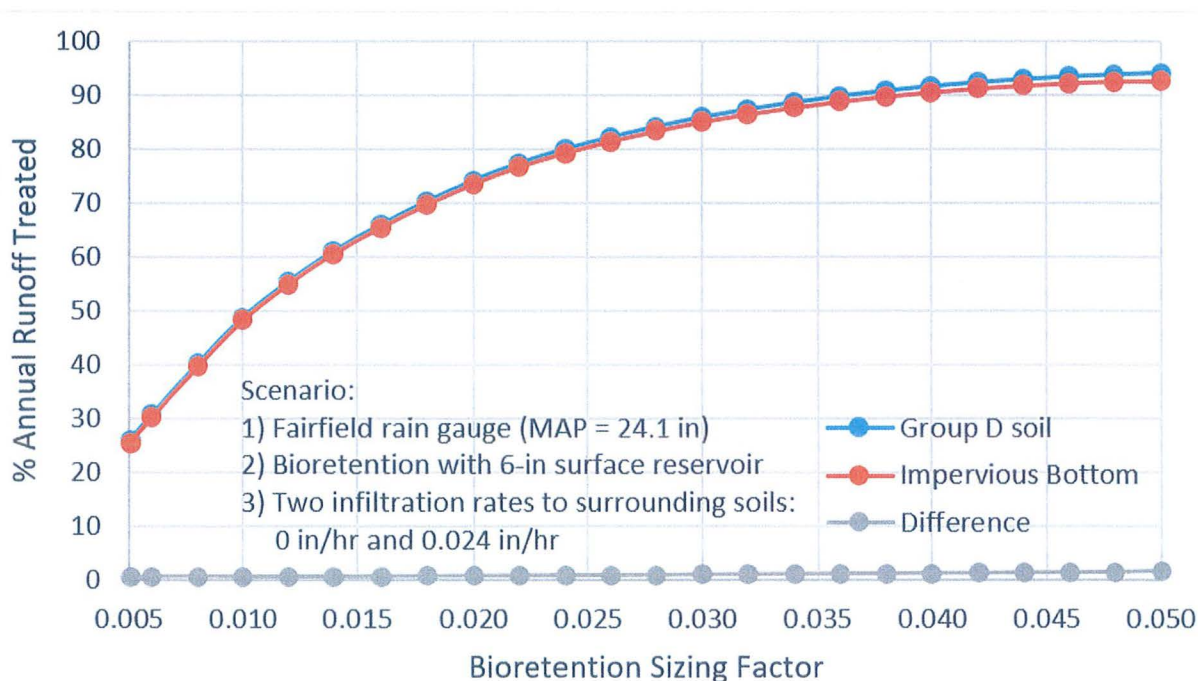

Figure 11. Comparison of model results for Group D soils and impermeable bottom scenarios

3.5 Percent of Annual Runoff Treated for Bioretention Facilities with Lower Media Permeability

The final modeling analysis examined the effect of modifying the bioretention media properties to reduce its saturated permeability from 5 inches per hour to 2 or 3 inches per hour. A lower permeability media would expand the list of available plantings and provide additional flexibility for landscape designers. However, the lower permeability would also reduce the bioretention's capacity for treating runoff during intense storms.

Due to budgetary constraints, this modeling analysis was limited to two scenarios: San Jose rain gauge, 6-inch surface reservoir depth, sizing factors ranging from 0.005 to 0.05, and saturated bioretention media permeability of 2 and 3 inches per hour. Figure 12 shows the percentage of annual runoff treated across the range of bioretention sizing factors and permeability rates. All of the scenarios include an underdrain, so the media permeability is the facility characteristic that controls the treatment percentage (i.e., the rate limiting step). The reduction in treatment percentage could be significant, particularly for smaller facilities. For example, the percent of annual runoff treated for a bioretention facility with a sizing factor of 0.02 would be reduced from 84 percent to 74 or 65 percent (for media permeability rates of 3 and 2 inches per hour, respectively).

Another way to consider the effect of lower media permeability is to estimate *how much larger a facility would need to be* to treat 80 percent of annual runoff. For the San Jose gauge, a sizing factor of 0.017 is needed with the standard bioretention media specification. If the media permeability were reduced to 3 or 2 inches per hour, the sizing factor needed to treat 80 percent of annual runoff would be 0.024 or 0.030, respectively, which represents a 37 to 75 percent increase in the facility footprint.

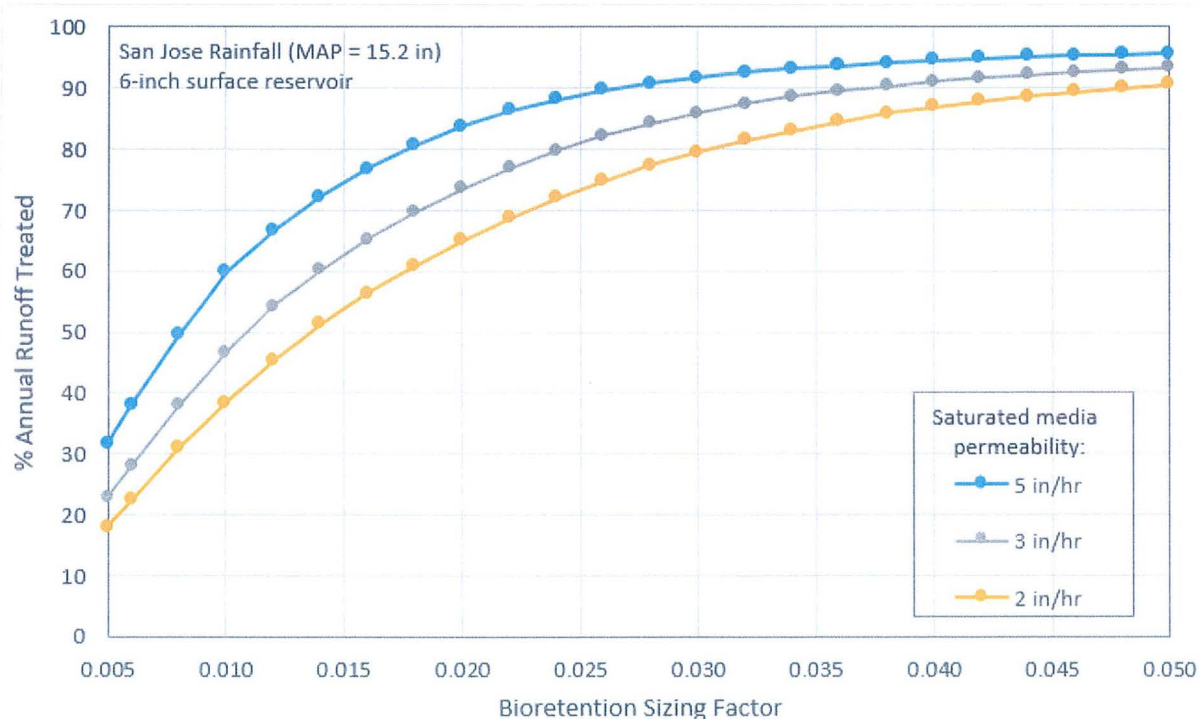

Figure 12. Treatment results for bioretention with variable media permeability, San Jose gauge (MAP = 15.2 in)

As a final note, the media permeability modeling was limited to two scenarios (one rain gauge, one facility configuration, two permeability rates). However, these results could be extended by noting that they are

generally similar to the “no underdrain” results shown in Section 3.3 (e.g., comparing the results for a media permeability of 2 inches per hour to a 2-inch per hour permeability of surrounding soil). When comparing the two sets of results, the percent of annual runoff treated for the lower media permeability is a little lower (0.5 to 2.5 percent) than the corresponding “no underdrain” scenario and the shape of the curve in Figure 12 is similar to the Figure 8 in Section 3.3.

4. Summary and Conclusions

Bioretention facilities are a useful and flexible approach for improving stormwater quality in urban areas. This project developed a set of useful tools that will help municipal staff plan green infrastructure projects in constrained public rights-of-way and assess the effectiveness of existing facilities.

1. Bioretention Sizing Criteria for 80 Percent Annual Runoff Treatment

The modeling analysis in Section 3.1 showed that bioretention facility performance is closely related to mean annual rainfall. For most locations, the bioretention area necessary to treat 80 percent of annual stormwater ranges from 1.5 to 2.5 percent of the connected upstream impervious area. The precise bioretention area necessary for any project within the BASMAA area (under the guidelines to be developed by BASMAA) can be calculated using the regression equations in Section 3.1.

2. General Sizing Relationships that Apply Throughout the BASMAA Area

The modeling analysis in Section 3.2 developed nomographs that estimate the annual stormwater treatment percentage across a range of bioretention facility sizes and mean annual rainfall depths. These nomographs can be used to estimate the annual treatment percentages for retrofit projects with space constraints and will enable municipal staff to compare bioretention with other treatment technologies. These nomographs can also be used to assess the effectiveness of existing facilities.

3. Performance of Bioretention Facilities with No Underdrain and Varying Rates of Permeability of Surrounding Soils

The modeling analysis in Section 3.3 demonstrated the relationship between stormwater treatment percentage and level of permeability of surrounding soils for bioretention facilities without an underdrain. Graphics were developed for rain gauges in wetter and drier areas. The results of this analysis can help assess existing installations and also inform designers about the benefits and tradeoffs of constructing bioretention with no underdrain.

4. Performance of Bioretention Facilities with No Infiltration

The modeling analysis in Sections 3.1 and 3.2 included the conservative assumption that bioretention facilities were installed in NRCS Group D soils with a very low permeability. The modeling analysis in Section 3.4 compared these results to bioretention facilities with no infiltration to surrounding soils (e.g., facilities with a liner or concrete bottom). The results were very similar, which confirms that the sizing guidance developed in Sections 3.1 and 3.2 can apply to flow-through planters or similar facilities that do not infiltrate to surrounding soils.

5. Sizing Criteria for Facilities with Lower Permeability Soil Media

The modeling analysis in Section 3.5 demonstrated the relationship between percent of annual runoff treated and bioretention soil media permeability. Reducing media permeability would allow for a wider range of bioretention plantings but would also result in a reduction in the percent of annual runoff treated for the same size drainage area. The reduction would be particularly notable for bioretention facilities with smaller sizing factors. The results of the bioretention media permeability analysis were similar to the no underdrain scenarios in Section 3.3. The Section 3.3 results could be used to estimate how reducing media permeability would influence treatment percentages across a wider range of scenarios.

In general, the bioretention surface area sizing criteria for treating 80% of the annual runoff derived from the modeling analyses described herein are significantly lower than the sizing factors that municipalities in the Bay Area have been requiring regulated projects to meet for compliance with permit requirements for some time. As stated in the Introduction (Section 1), the BASMAA Development Committee and BASMAA member agencies intend to use these sizing relationships to develop and justify a “single approach” for implementing non-regulated green street projects when there are constraints on facility size. A work group of the Development Committee was formed to develop policies and guidelines for implementing the new sizing criteria and addressing other related issues. These include defining the conditions, constraints, and types of projects for which the reduced sizing factors can be used; the method for applying the sizing factors; guidelines for when dimensions of other components such as media depths can be adjusted; how the design of other types of green infrastructure measures may be modified; the effectiveness of smaller or modified green infrastructure facilities in terms of pollutant load reduction; and other considerations.

5. References

- Contra Costa Clean Water Program (CCCWP). 2006. Hydrograph Modification Management Plan. April 16, 2006.
- Contra Costa Clean Water Program (CCCWP). 2013. IMP Monitoring Report, IMP Model Calibration and Validation Report. September 20, 2013.

Appendix A: Storm Depths for 1-Hour and 24-Hour Durations

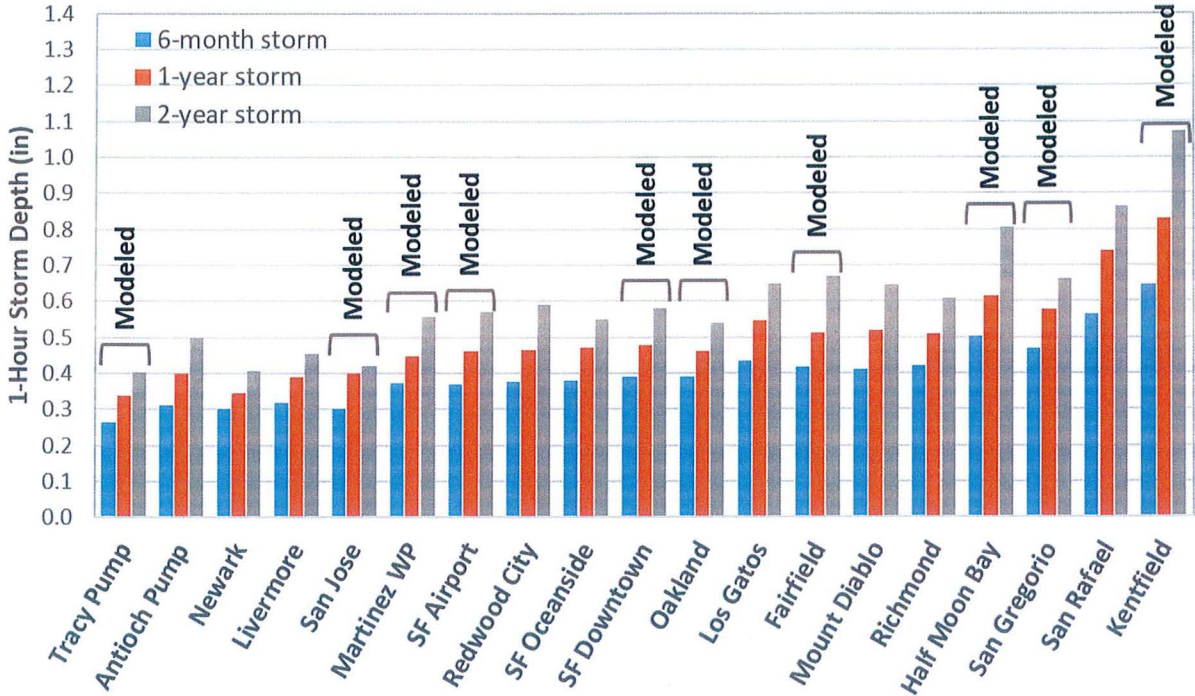

Figure 13. Storm depths for 1-hour duration

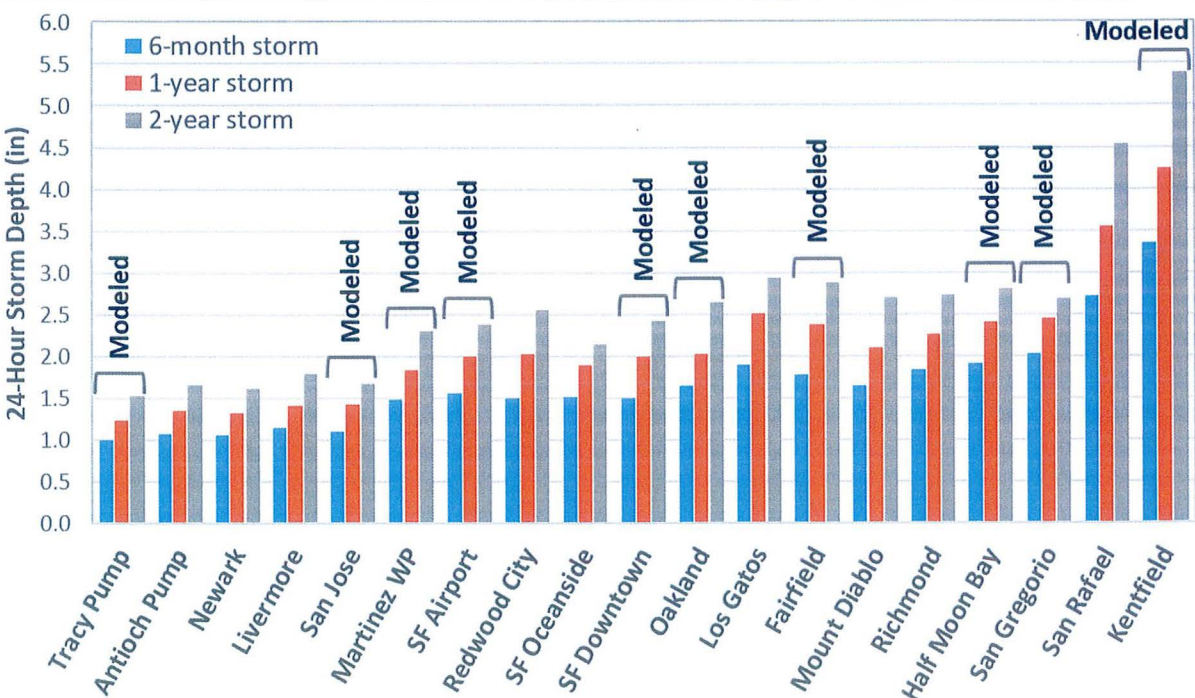

Figure 14. Storm depths for 24-hour duration

Appendix B: Treatment Percentage Results Graphics for All Rain Gauges

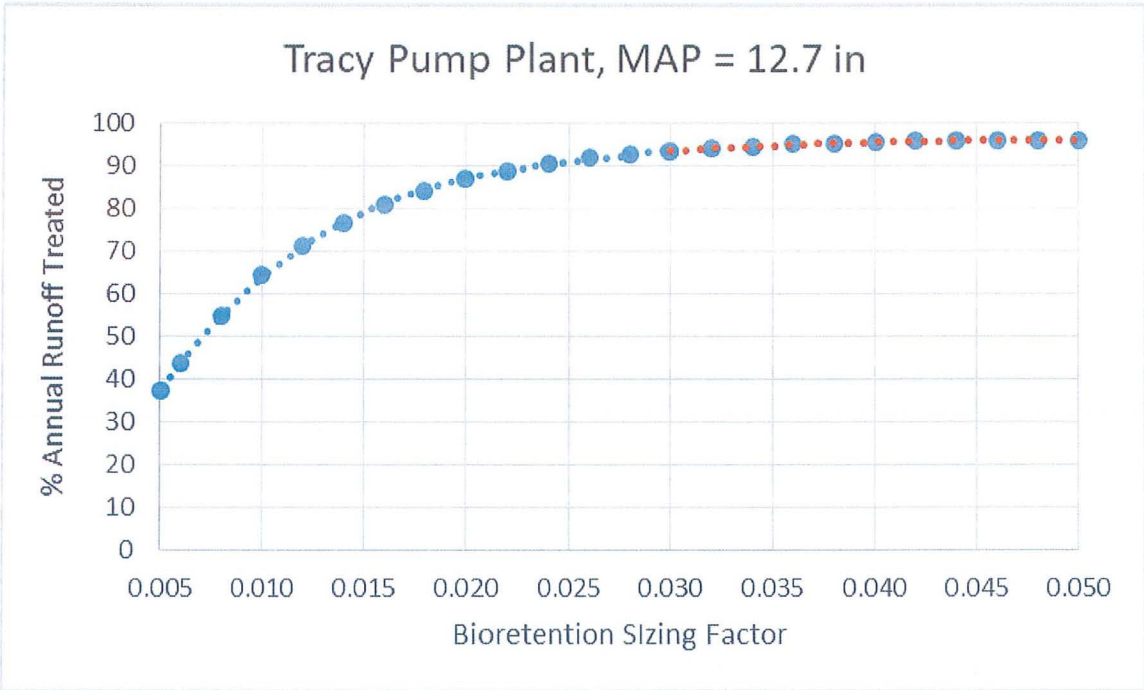

Figure 15. Annual treatment percentage for the Tracy Pump Plant rain gauge

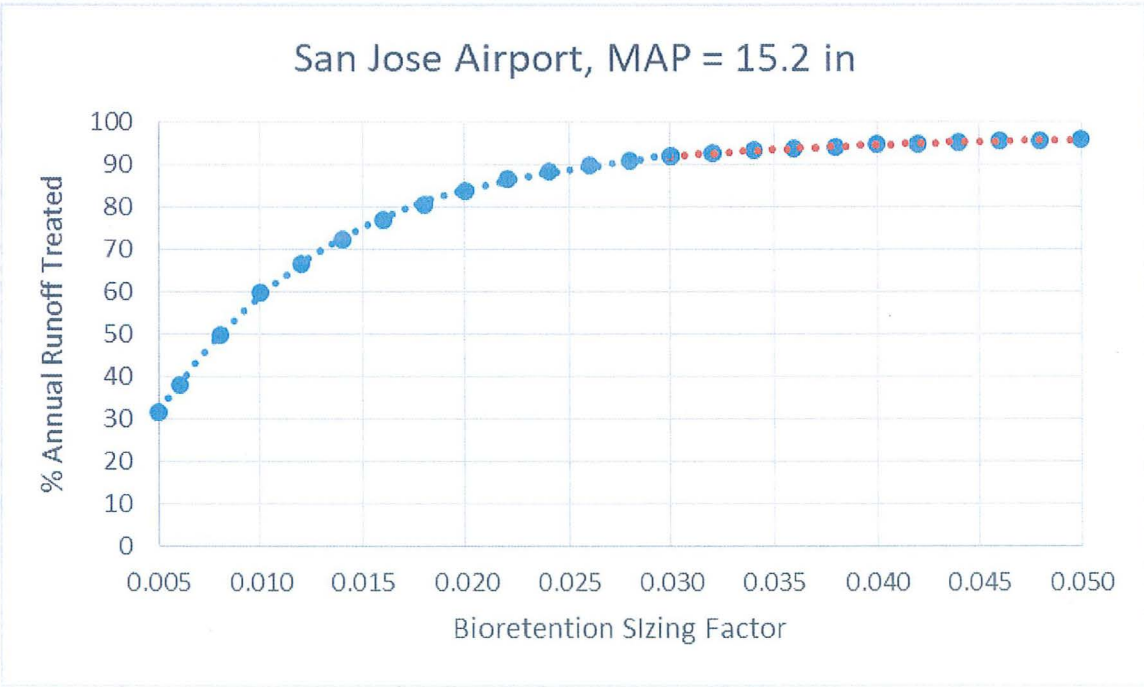

Figure 16. Annual treatment percentage for the San Jose rain gauge

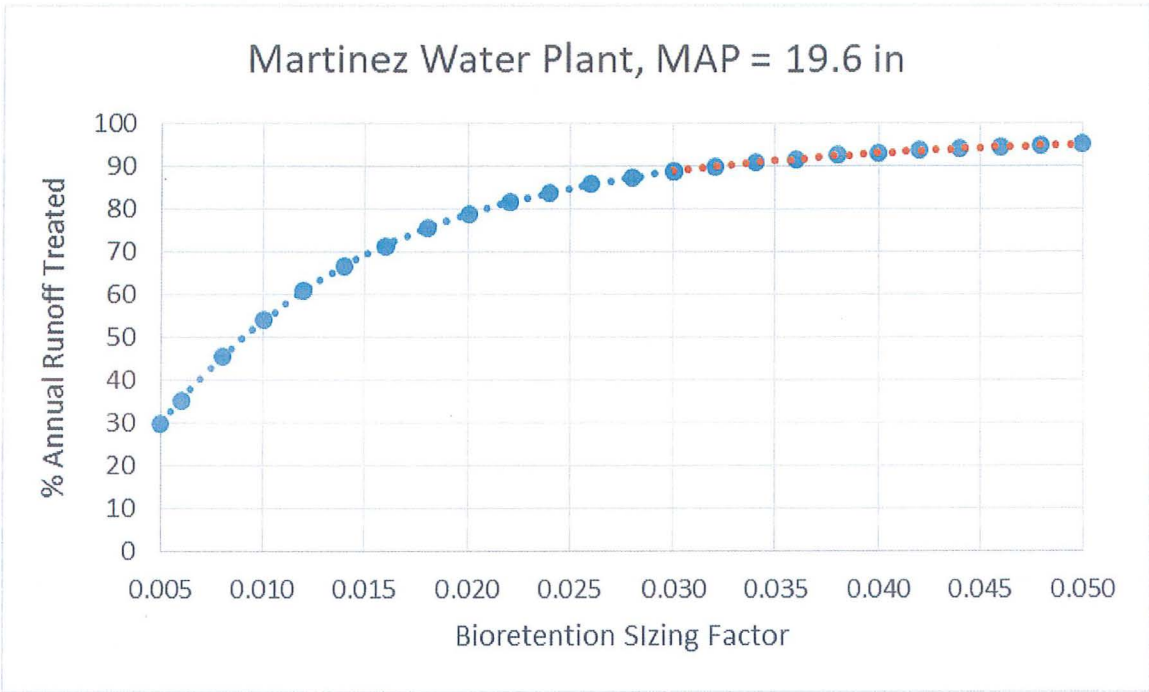

Figure 17. Annual treatment percentage for the Martinez Water Plant rain gauge

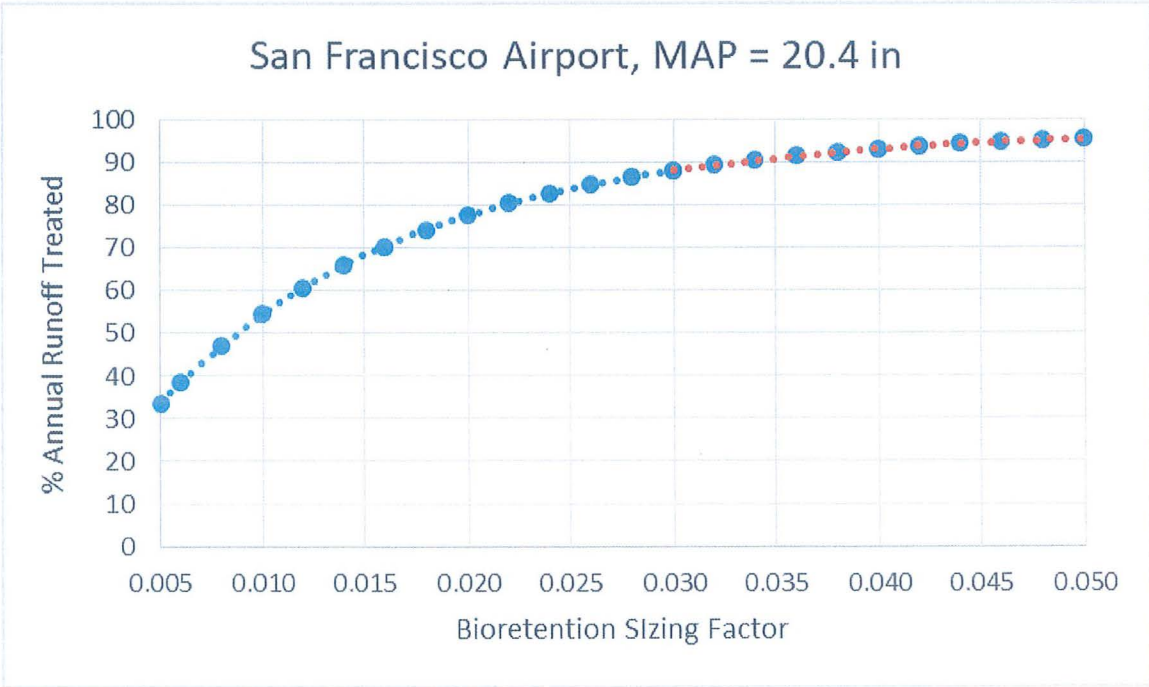

Figure 18. Annual treatment percentage for the San Francisco Airport rain gauge

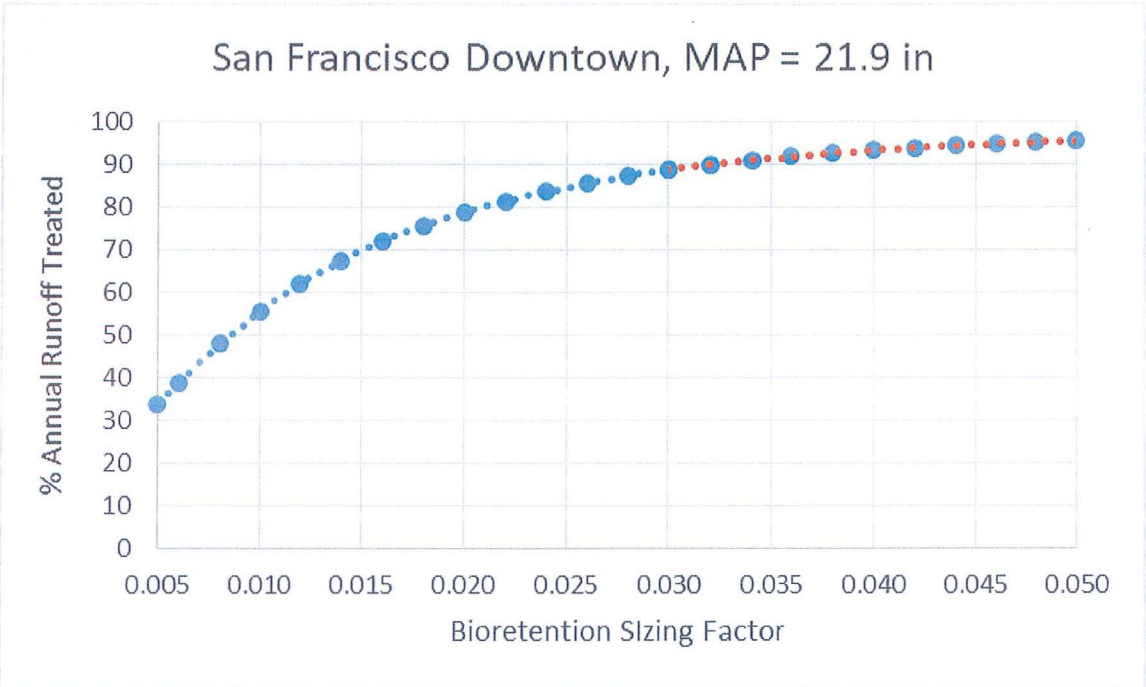

Figure 19. Annual treatment percentage for the San Francisco Downtown rain gauge

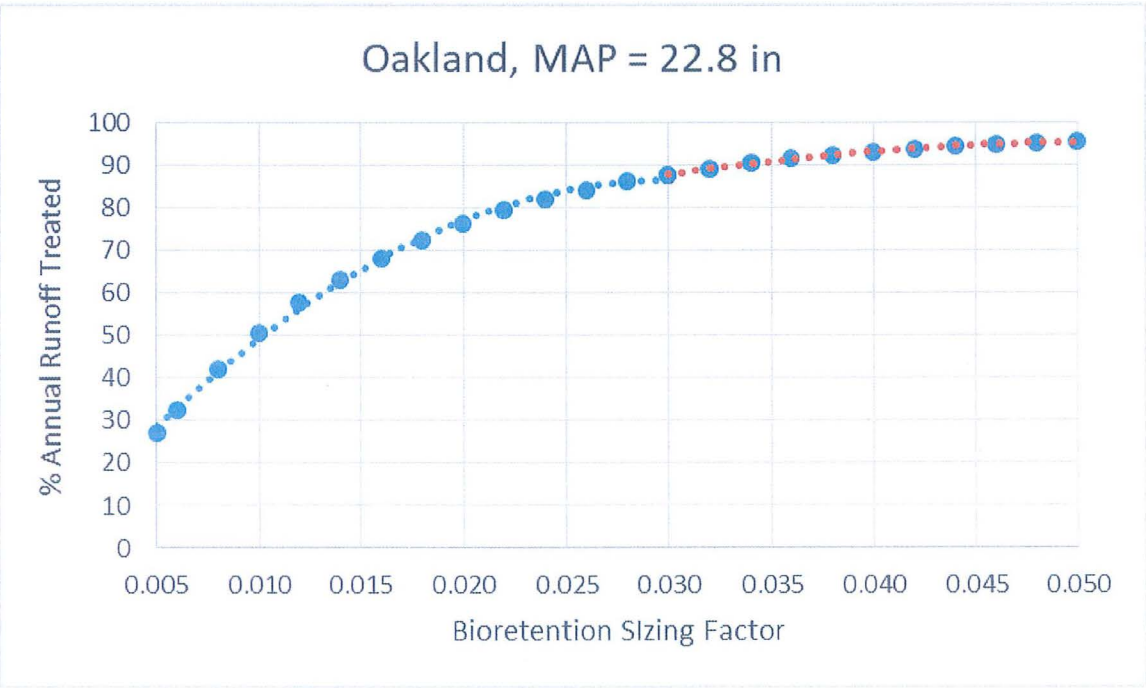

Figure 20. Annual treatment percentage for the Oakland rain gauge

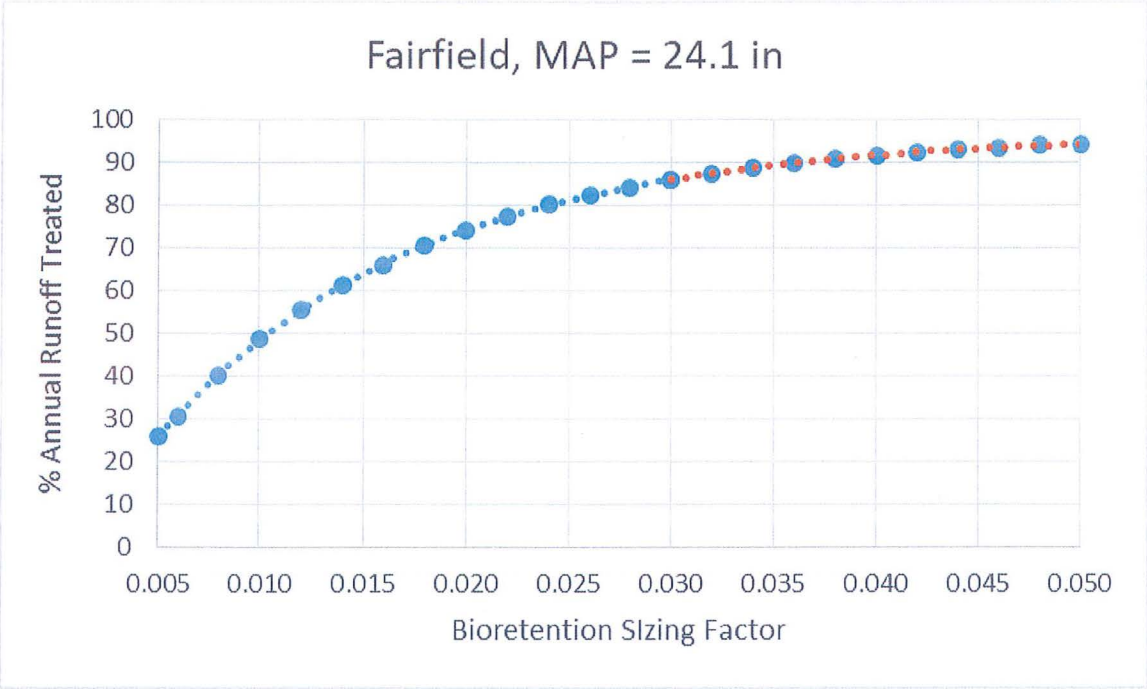

Figure 21. Annual treatment percentage for the Fairfield rain gauge

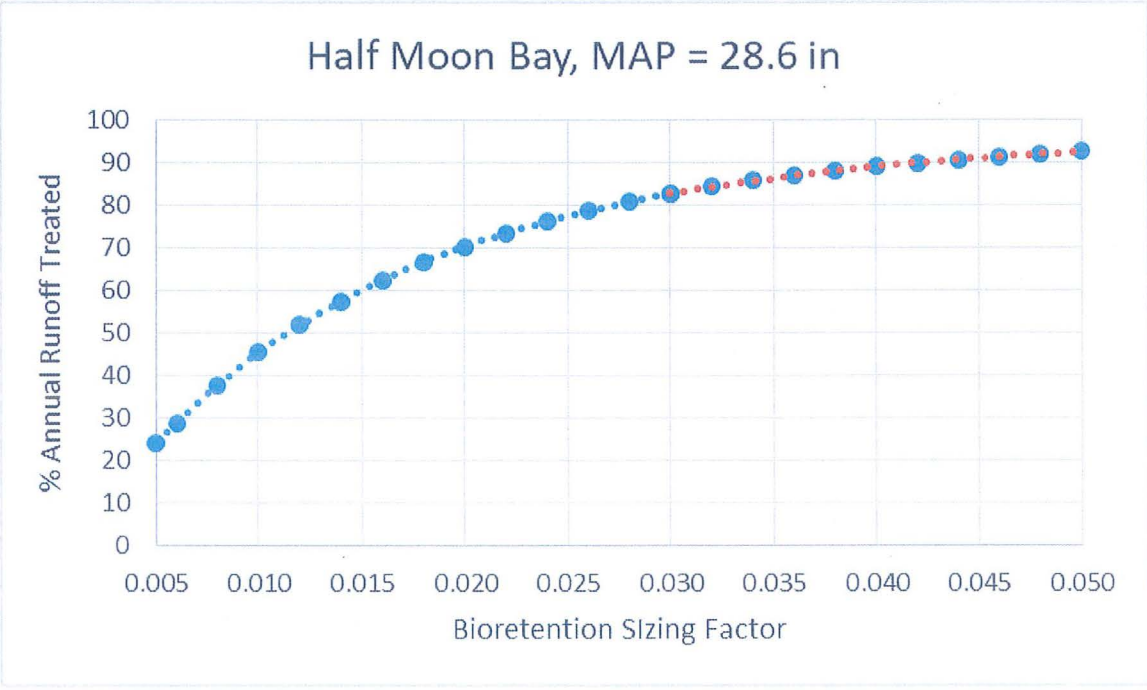

Figure 22. Annual treatment percentage for the Half Moon Bay rain gauge

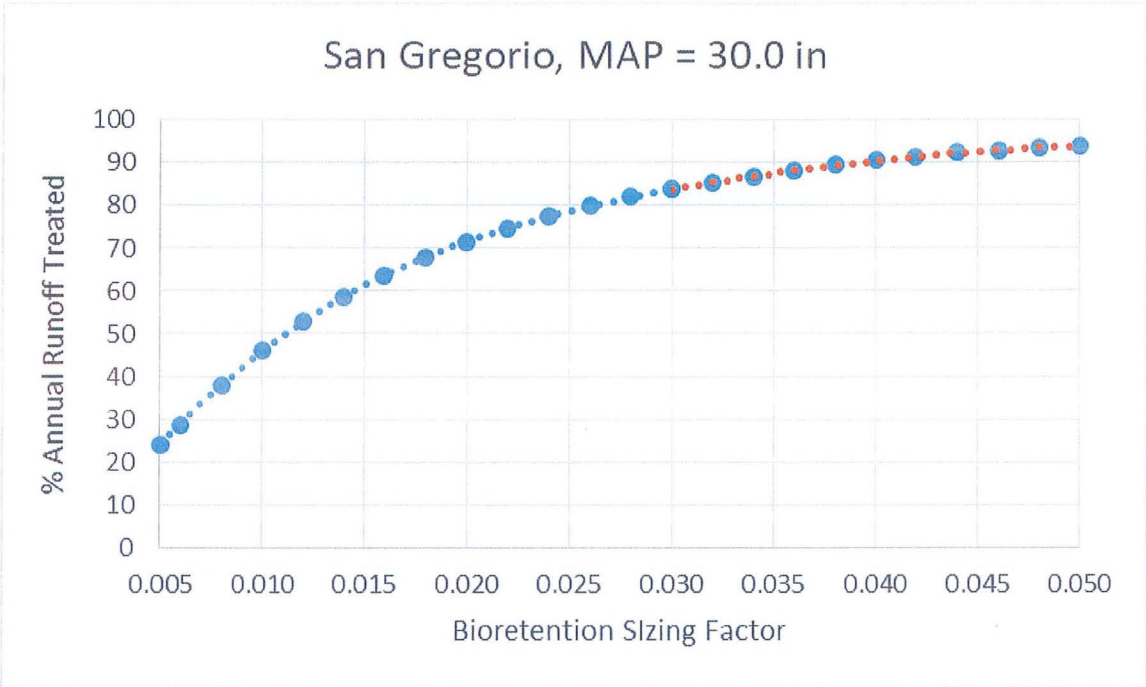

Figure 23. Annual treatment percentage for the San Gregorio rain gauge

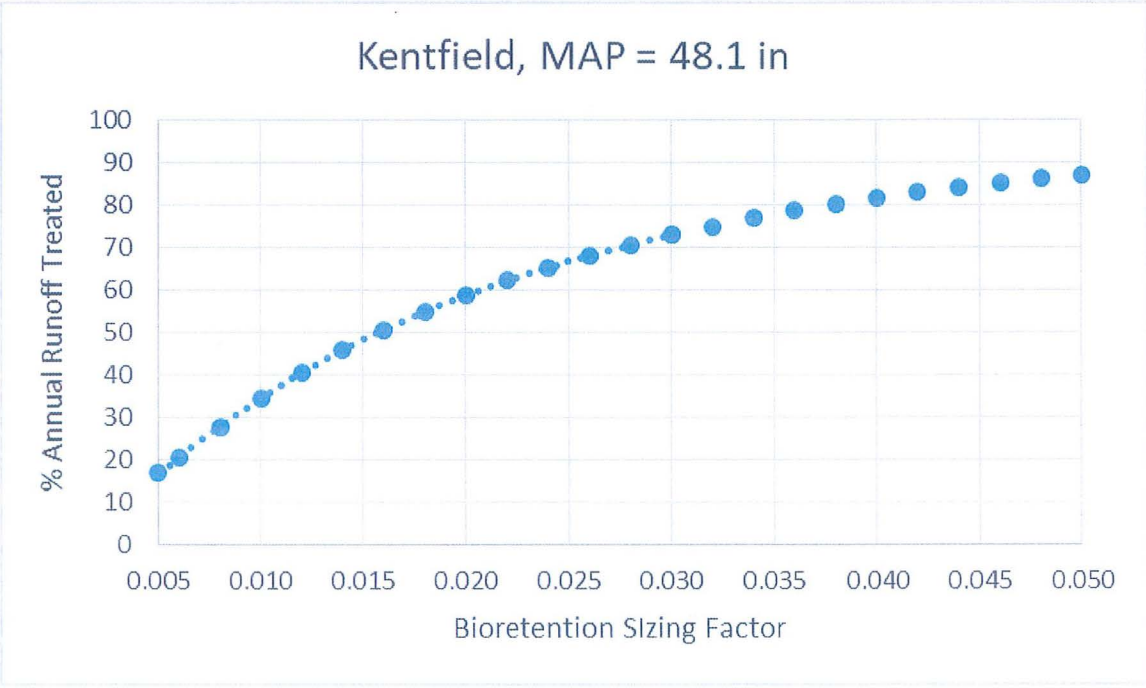

Figure 24. Annual treatment percentage for the Kentfield rain gauge

Appendix C: Bioretention with No Underdrain, 12-inch Surface Reservoir Results

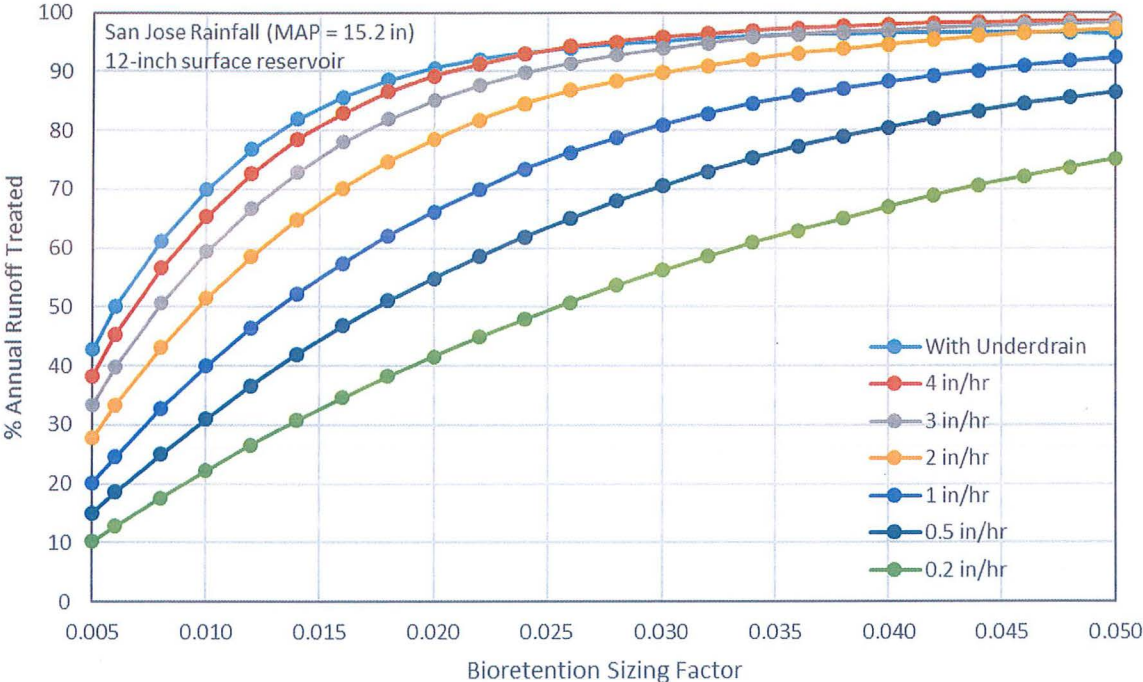

Figure 25. Treatment results for bioretention with no underdrain, San Jose gauge (MAP = 15.2 in)

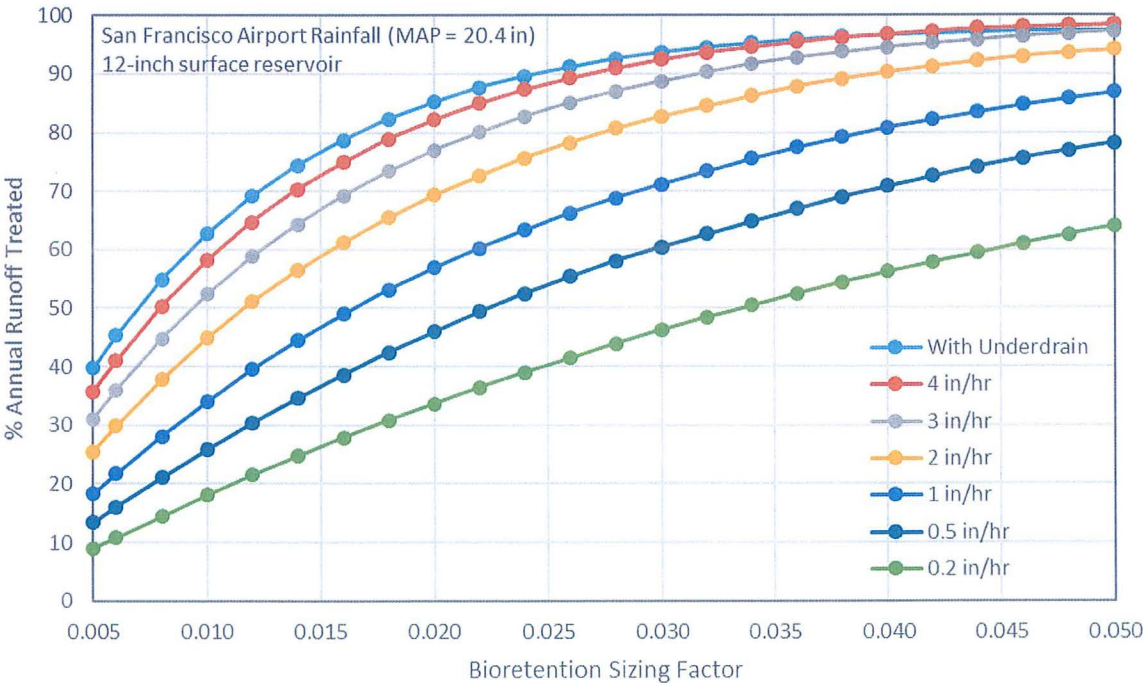

Figure 26. Treatment results for bioretention with no underdrain, San Jose gauge (MAP = 15.2 in)

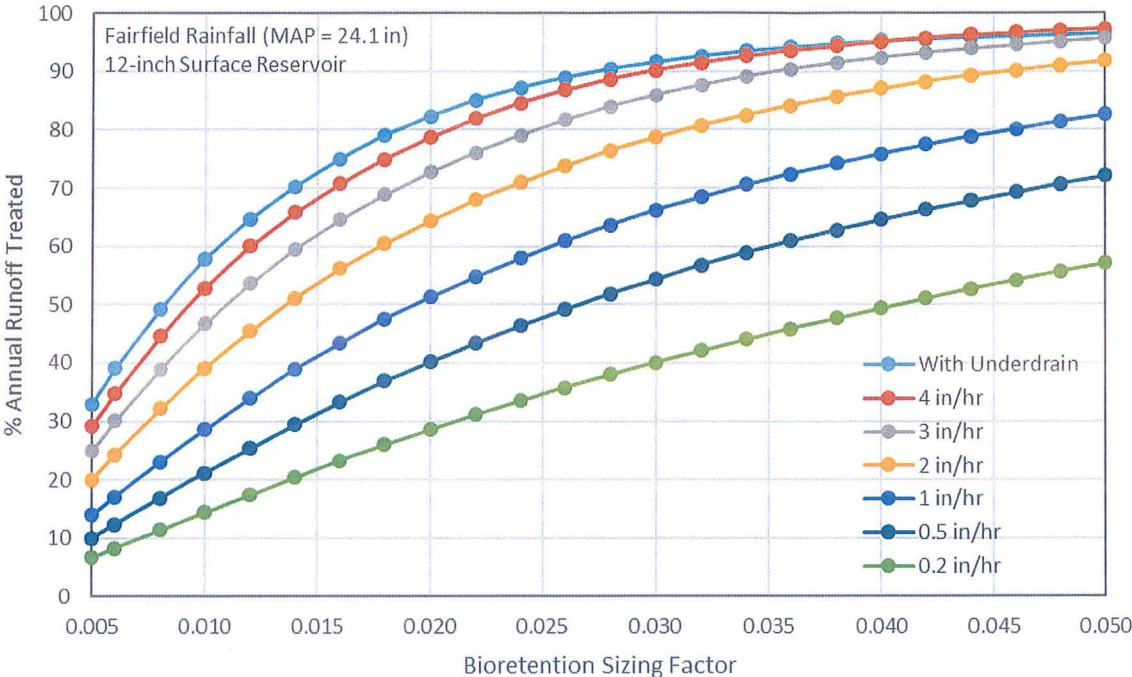

Figure 27. Treatment results for bioretention with no underdrain, San Jose gauge (MAP = 15.2 in)

Appendix C. Workplan to Incorporate Green Infrastructure Requirements in City of Hayward's Bicycle and Pedestrian Master Plan Update

This page intentionally left blank

APPENDIX C

Workplan to Incorporate Green Infrastructure Requirements in the City of Hayward Bicycle & Pedestrian Master Plan Update

1. Statement of Purpose

The purpose of this workplan is to identify how the City of Hayward (City) will ensure that green infrastructure (GI) and low impact development (LID) measures are appropriately included in the City's Bicycle & Pedestrian Master Plan update, which may affect the future alignment, configuration, and design of impervious surfaces within its jurisdiction. The planning process and schedule for this update is discussed below.

2. Planning Process

As described on the City's website,¹ the planning process for the City's Bicycle & Pedestrian Master Plan update began in May 2018 and will continue through October 2019, as summarized below.

Phase 1: Establish Foundation

In Phase I, the City solicited input from residents, businesses, and other stakeholders about existing barriers to walking and biking, and where the City should identify new project recommendations.

Phase II: Initial Recommendations

In Phase II, the City compiled community input to create draft project and programmatic recommendations for the community to review prior to inclusion in the final plan document.

Phase III: Prioritization & Final Recommendations

The City is currently in the process of creating a final list of bicycle and pedestrian projects, and will use community input and findings from Phases I and II to prioritize projects for implementation and future grant applications. During this phase, City staff anticipates incorporating GI requirements and recommendations in the Bicycle & Pedestrian Master Plan update.

Phase IV: Draft & Final Plan

During the summer of 2019 the City is scheduled to complete a Draft Bicycle & Pedestrian Master Plan update and release it for public review. City Council adoption of the Final Plan is anticipated

¹ Information on the Bicycle & Pedestrian Master Plan update is available at www.hayward-ca.gov/content/bike-and-pedestrian-master-plan-update.

in the fall of 2019. The final approval of the Bicycle & Pedestrian Master Plan update is anticipated to include documentation of stakeholder coordination and outreach.

3. Schedule

Updates to the Bicycle and Pedestrian Master Plan are anticipated to be completed in Fiscal Year 2019/20. The following schedule indicates the timeframes in which Phases I and II were completed, and when Phases III and IV are scheduled to be implemented.

Phase I: Establish Foundation (May – August 2018) *complete*

Phase II: Initial Recommendations (September 2018 - March 2019) *complete*

Phase III: Prioritization & Final Recommendations (April 2019 - June 2019) *in process*

Phase IV: Draft & Final Plan (July - October 2019) *future phase*